



AUTOPARTES ORIGINALES



Catálogo 2012

Triher S.A. es una empresa argentina dedicada a la fabricación, importación y exportación de autopartes eléctricas originales.

Nace en el año 1997 como expresión para el After Market de la marca **VuaRam**, la misma cuenta con una trayectoria de más de 50 años en el mercado argentino, siendo equipo original de Fiat, Peugeot, Renault, Mercedes Benz, Iveco, Eaton, Deutz y Volkswagen.

A la fabricación de su propia marca **VuaRam**, la empresa ha incorporado en los últimos años la comercialización de otras marcas de prestigio internacional como Kostal, Dav, Amperauto, Trw, Indebras, Siemens, Magneti Marelli, Carto, para satisfacer las necesidades del actual parque automotor argentino.

El objetivo que persigue **Triher S.A.** es seguir a la vanguardia en el segmento de las llaves conmutadoras de luces y limpiaparabrisas, llaves teclas e interruptores, sensores de nivel de combustible, electroválvulas y espejos retrovisores interiores, a través del constante desarrollo e incorporación de nuevos productos.

Nuestras operaciones abarcan el ámbito nacional, a través de nuestra red de distribuidores; cómo así también el Mercosur, Centroamérica, Norte de África y Europa.

En todos los casos, sean productos de nuestra propia fabricación o importados, nuestro departamento técnico tiene a su cargo la aprobación de la calidad total. De esta forma **Triher S.A.** garantiza y avala todas las autopartes que comercializa.

***Triher S.A.** is an Argentine company specializing in manufacturing, importing and exporting of original electric spare parts. The company started operations in 1997, providing service to the Argentine market with **VuaRam** products, a brand that has over 50 years in the Argentine market and is part of the original equipment for Fiat, Peugeot, Renault, Mercedes Benz, Iveco, Eaton, Deutz and Volkswagen.*

*In addition to manufacturing its own brand **VuaRam**, in the last few years the company has started the commercialization of other internationally known brands such as Kostal, Dav, Amperauto, Trw, Indebras, Siemens, Magneti Marelli and Carto, in order to meet the needs of the current Argentine car market.*

***Triher S.A.** goal is to continue at the forefront of the market for lights and wiper control switches and other switches, fuel level senders, electrovalves and rear view mirrors through the continuous development and incorporation of new products.*

In addition to the domestic market, we operate through our distribution network in Mercosur countries, Central America, northern Africa and Europe.

*Whether in relation to products manufactured by us or imported, our technical department is always involved in the approval of the product's overall quality. As a result, **Triher S.A.** warrants all spare parts it sells*

Índice general

Index



**Llaves conmutadoras de
luces y l. parabrisas**
Lights control switches

pag. 3

**Sensores de nivel
de combustible**
Fuel level senders

pag. 19

**Llaves teclas
e interruptores**
General switches

pag. 31

**Interruptores de ignición
Contactores de arranque**
Ignition switches

pag. 51

**Bombas eléctricas
de combustible**
Electric fuel pumps

pag. 57

**Tabla de Equivalencias
OEM Codes**

pag. 59

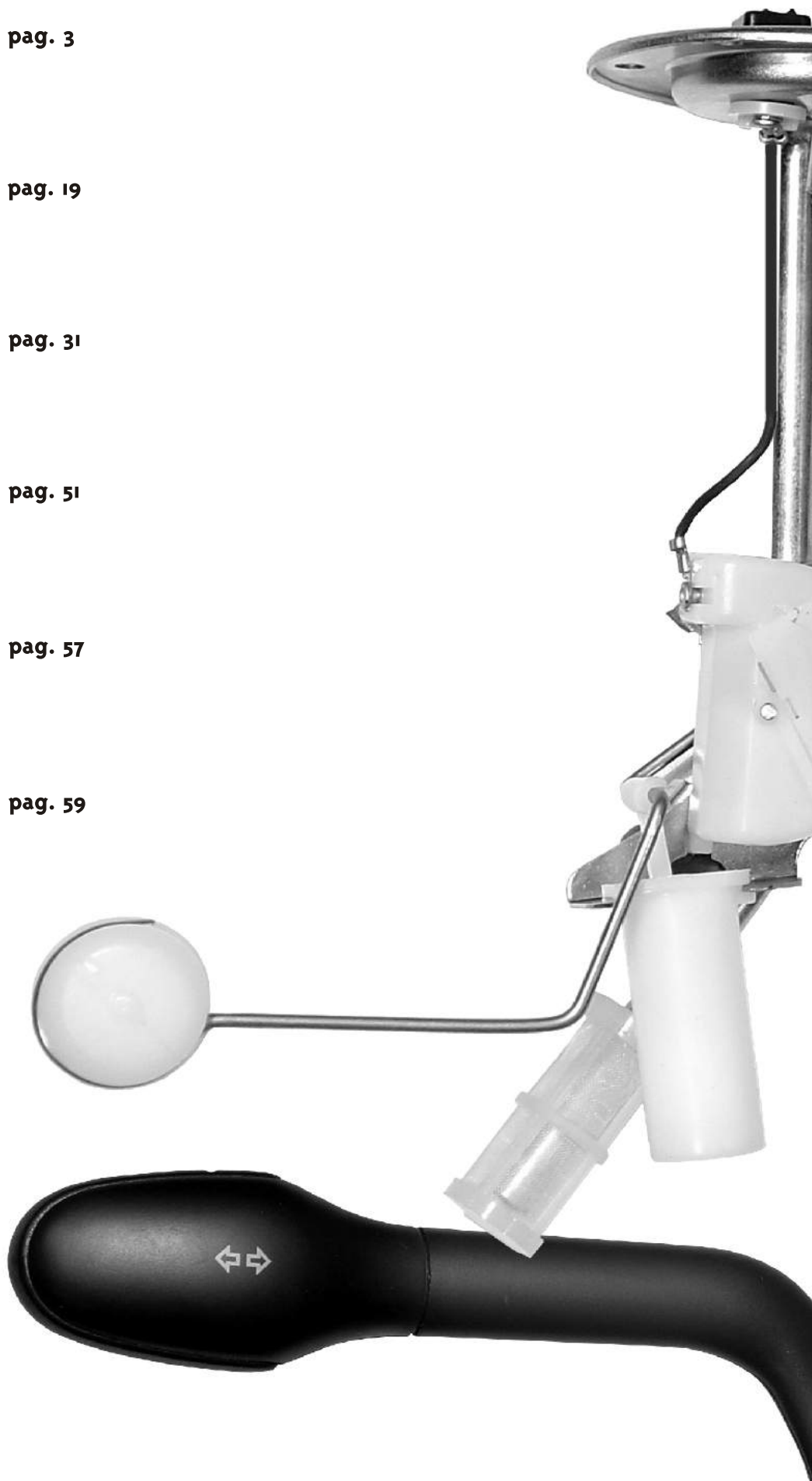
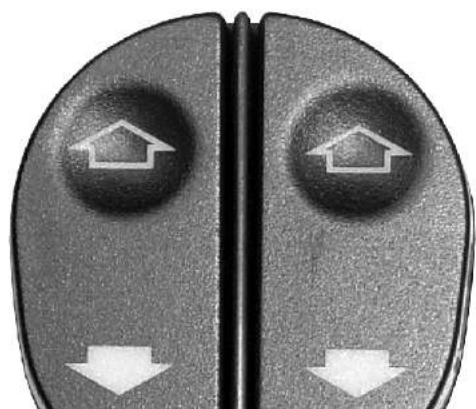

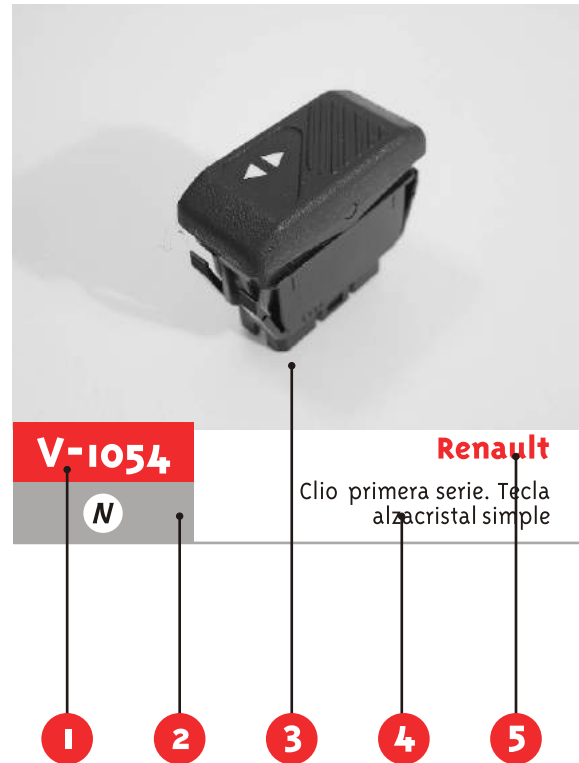

- 1 | **Código de producto**
Product code
- 2 | **Origen (N: Nacional, I: Importado)**
Origin (N: For export, I: Imported)
- 3 | **Imágen del producto**
Product image
- 4 | **Descripción del producto**
Product description
- 5 | **Línea**
Automotive line

Llaves conmutadoras de luces y l. parabrisas
Lights, wiper and horn control switches

VuaRam[®]
AUTOPARTES ORIGINALES

Fiat

Peugeot

Renault

Citröen

Mercedez Benz

General Motors

Ford

Volkswagen

Lada

Alfa Romeo

Scania

Toyota

Seat

Suzuki





V-09

N

Fiat

1600/125 Primera serie - Dos conectores 6 y 6 vías



V-10

N

Fiat

125 Dirección articulada - Dos conectores 6 y 6 vías



V-11

N

Fiat

125 Multicarga - Dos palancas
Un conector de 6 vías



V-12

N

Fiat

128 Primera Serie - Dos conectores de 8 y 6 vías



V-14

N

Fiat

125 Segunda serie (Color negro)
Dos conectores 6 y 4 vías



V-16

N

Fiat

125 Segunda serie (Negro)- 3 conectores 6, 3 y 1 vía



V-18

N

Fiat

128 Europa (Negro) - 3 conect. 8, 6 y 1 vía - con lavaparabrisas



V-22

N

Fiat

128 Europa (Gris)- 3 conect. 8, 6 y 1 vía - con lavaparabrisas



V-23

N

Fiat

133 Todos los modelos - 3 conectores 6, 4 y 4 vías



V-31

N

Fiat

147 / Spazio / Vivace / Fiorino (negro)
3 conectores 6, 4 y 4 vías



V-34

N

Fiat

147 / Spazio / Fiorino (negro)
c/l.parabrisas. 3 conectores 6, 4 y 4 vías



V-36

N

Fiat

147 / Spazio - Color Gris
c/l.parabrisas. 3 conectores 6, 4 y 4 vías

Llaves conmutadoras de luces y l. parabrisas
Lights, wiper and horn control switches

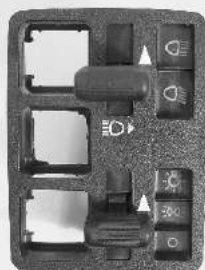

V-401

Fiat

Duna / Uno 1988-1994
Llave satelital de luces

N



V-404

Fiat

Uno / Duna Weekend 1995-2003
Conmutador con lavaluneta

N



V-405

Fiat

Duna / Uno base 1995-2003
Conmutador completo s/lavaluneta

N



V-410

Fiat

Ducato - 1995/1996 - 2 conectores
7 y 9 vías

N



V-417

Fiat

Palio / Siena 1996-2000
Conmutador con lavaluneta

I



V-418

Fiat

Siena / Palio base 1996-2000
Conmutador s/lavaluneta

I



V-1045

Fiat

Ducato - desde 1999
Un conector 16 vías

N



V-1050

Fiat

Ducato - 1996/1999. 2 conectores
7 y 9 vías

N



V-1141

Fiat

Palio / Siena Weekend 1996-2000
Conmutador con airbag

I



V-1191

Fiat

Palio 2000-2004. Conmutador luces y
l. parabrisas c/lav.trasero

I



V-1192

Fiat

Palio 2000-2004. Conmutador luces y
l. parabrisas c/lav.trasero + airbag

I



V-1192/I

Fiat

Palio / Palio Weekend 2000-2004
c/lavaluneta y c/airbag

I



V-1280

Fiat

Uno Fire desde 2003
Conmutador completo con lavaluneta

I



V-1281

Fiat

Uno / Fiorino Fire desde 2003
Conmutador completo s/lavaluneta

I



V-1335

Fiat

Siena desde 2007. Conmutador
completo s/lavaluneta y con baliza

I



V-1336

Fiat

Siena 2004-2007. Conmutador
completo s/lavaluneta

I



V-39

Peugeot

504 auto y Pick-up (gris) 1990-1993
Conectores 6 y 8 vias

N



V-40

Peugeot

504 auto y Pick-up (negro) 1993-1994
Conectores 6 y 8 vias

N



V-41

Peugeot

504 auto y Pick-up (negro) 1994-1998
Conectores de 8 vias

N



V-41/1

Peugeot

504 G base (negro) 1998-2000
Conectores de 8 vias macho

N



V-304

Peugeot

505 gama -Palanca de
luces giros y bocina

N



V-305

Peugeot

405 hasta 1993 / 205 todos
Palanca de luces giros y bocina

N



V-410

Peugeot

Boxer 1995-1996
2 conectores 7 y 9 vias

N



V-996

Peugeot

405 1993-2000
Palanca de luces, giros y bocina

I

Llaves conmutadoras de luces y l. parabrisas
Lights, wiper and horn control switches



V-997 Peugeot
 405 1993-2000
 Palanca de limpiaparabrisas



V-998 Peugeot
 306 1993-1998
 Palanca de luces, giros y bocina



V-999 Peugeot
 306 1993-2000
 Palanca de limpiaparabrisas y luneta



V-1000 Peugeot
 306 1993-2000
 Palanca de luces, giros y bocina



V-1001 Peugeot
 306 1993-1998
 Palanca de limpiaparabrisas s/luneta



V-1002 Peugeot
 306 desde 1999
 Palanca de luces y giros

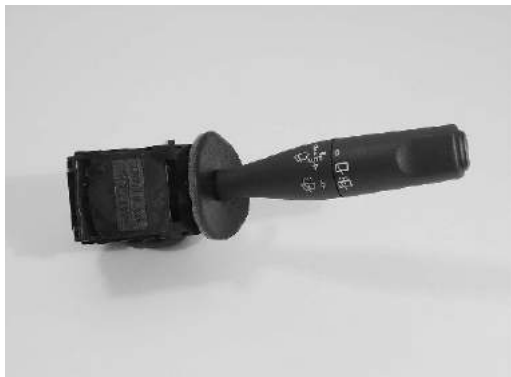

V-1003 Peugeot
 306 desde 1999
 Palanca limpiaparabrisas y luneta



V-1004 Peugeot
 306 desde 1999
 Palanca de luces y giros



V-1005 Peugeot
 306 desde 1999
 Palanca limpiaparabrisas s/ luneta



V-1006 Peugeot
 Partner 1998-2010
 Palanca de luces, giros y bocina



V-1007 Peugeot
 Partner 1998-2010
 Palanca limpiaparabrisas y luneta



V-1045 Peugeot
 Boxer - desde 1999 - Un conector 16 vías



V-1050

Peugeot

Boxer -1996/99 - 2 conectores
7 y 9 vías

N



V-1082

Peugeot

206 1998-2003. Palanca de luces, giros
y bocina, c/faros neblineros

I



V-1127

Peugeot

206 1998-2003. Palanca de luces, giros
sin bocina, c/faros neblineros

I



V-1155

Peugeot

106 -Palanca luces
giros y bocina

I



V-1239

Peugeot

406
Palanca de luces y bocina

I



V-1240

Peugeot

406
Palanca de l. parabrisas

I



V-1241

Peugeot

505 gama desde 1986
Palanca de l. parabrisas

I



V-1082/I

Peugeot

206 1998-2003. Palanca de luces, giros,
bocina, c/faros neblineros y retroniebla

I

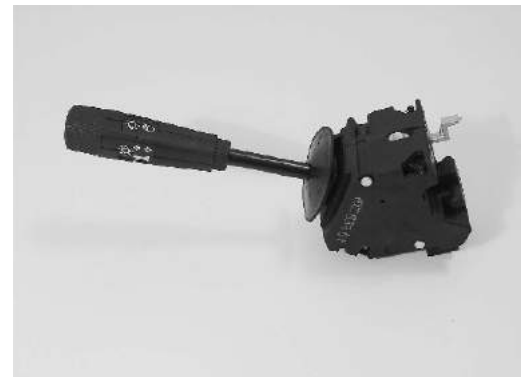

V-306

Renault

9 / 11 -Palanca de luces
giros y bocina

N



V-308

Renault

21 / 19 Chamade -Palanca de
luces giros y bocina

N



V-310

Renault

18 / Fuego -Palanca de
luces giros y bocina

N



V-1010

Renault

Clio Primera serie 1994-1999
Palanca de luces, giros y bocina

N

Llaves conmutadoras de luces y l. parabrisas
Lights, wiper and horn control switches



V-1011

Renault

N

19 1993-1999
Palanca de luces, giros y bocina



V-1073

Renault

N

Trafic Primera serie. 1986-1996
Palanca de luces, giros y bocina



V-1074

Renault

N

Express -Palanca de
luces giros y bocina



V-1075

Renault

N

12 / Torino desde 1979
Palancas de luces giros y bocina



V-1120

Renault

N

Twingo hasta 1998. Palanca
de luces, giros y bocina color negra



V-1121

Renault

N

Twingo desde 1998. Palanca
de luces, giros y bocina color gris



V-1223

Renault

I

Clio II desde 2000
Palanca de luces, giros y retroniebla



V-1224

Renault

I

Clio II desde 2000. Palanca de luces,
giros, retroniebla y neblina



V-1225

Renault

I

Kangoo 1998-2001
Palanca de luces, giros y retroniebla



V-1226

Renault

I

Kangoo / Scenic 1998-2001. Palanca
de luces, giros, retroniebla y neblina



V-1227

Renault

I

Kangoo / Scenic 1998-2001
Palanca de luces, giros y retroniebla



V-1228

Renault

I

Megane / Scenic desde 2000
Palanca de luces, giros y retroniebla



V-1229

Renault

Megane / Scenic desde 2000
Pal. luces, giros, retroneblina y neblina

I



V-1230

Renault

Megane / Scenic desde 2000
Pal. l.parabrisas y luneta + luneta term.

I



V-1231

Renault

Megane / Scenic desde 2000
Palanca limpiaparabrisas y luneta

I



V-1232

Renault

Kangoo desde 2000
Palanca limpiaparabrisas y luneta

I



V-1233

Renault

Kangoo desde 2000
Palanca limpiaparabrisas

I



V-1333

Renault

Master/Trafic dde.2006.Megane hasta 2000. Palanca de luces, giros y bocina

I



V-1155

Citröen

Saxo -Palanca de
luces giros y bocina

I



V-1243

Citröen

Xsara. Palanca de luces,
giros y bocina

I



V-1244

Citröen

Xsara
Palanca de l. parabrisas

I



V-30

Mercedes Benz

Camion 1214 -Palanca luces giros
y bocina inclinada comun

N



V-30/1

Mercedes Benz

Camion 1114 -Palanca luces giros
y bocina recta comun

N



V-30/2

Mercedes Benz

Camion 608 -Palanca luces giros
y bocina inclinada corta comun

N

Llaves conmutadoras de luces y l. parabrisas
Lights, wipper and horn control switches



V-30/3

Mercedes Benz

Camión 1314/1318/OH -Palanca
luces giros y bocina curva común

N



V-30 A

Mercedes Benz

Camión 1214 -Palanca luces giros y
bocina incl. c/guiñada -conect. 8 y 1 vía

N



V-30/1A

Mercedes Benz

Camión 1114 -Palanca luces giros y
bocina rta. c/guiñada -conect. 8 y 1 vía

N



V-30/2A

Mercedes Benz

Camión 608 -Palanca luces giros y
bocina incl. cta. c/guiñ. -conect. 8 y 1 vía

N



V-30/3A

Mercedes Benz

Cam. 1314/1318/OH -Palanca luc. giros y
bocina cva. c/guiñada -conect. 8 y 1 vía

N



V-30 B

Mercedes Benz

Camión 1214 -Palanca luces giros y
bocina incl. c/guiñada -conect. 8 y 2 vías

N



V-30/1B

Mercedes Benz

Camión 1114 -Palanca luces giros y
bocina rta. c/guiñada -conect. 8 y 2 vías

N



V-30/2B

Mercedes Benz

Camión 608 -Palanca luces giros y bocina
incl. cta. c/guiñada -conect. 8 y 2 vías

N



V-30/3B

Mercedes Benz

Cam. 1314/1318/OH -Palanca luc. giros y
bocina cva. c/guiñada -conect. 8 y 2 vías

N



V-30/7

Mercedes Benz

Camión 1992-1995. Palanca luces,
bocina y l. parabrisas, color marrón

I

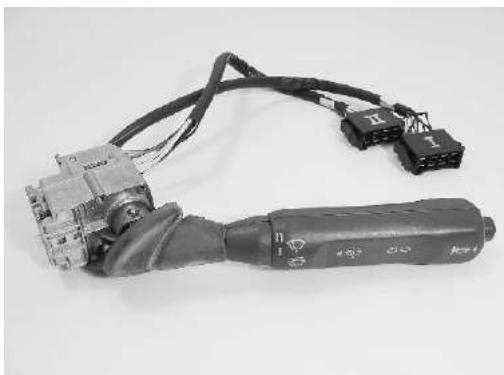

V-30/8

Mercedes Benz

Camión 1995-2005. Palanca luces,
bocina y l. parabrisas, color negro

I



V-1030

Mercedes Benz

Sprinter -Conmutador completo
luces baliza y l. parabrisas

I



V-1289

Mercedes Benz

Camiones dde. 2000. Electrónicos
palanca multifunción color gris

I



V-821/I

General Motors

Corsa 1994-2010 / Vectra
Palanca luces y giros

N



V-827

General Motors

Corsa 1994-2010 / Vectra Primera serie
Palanca de limpiaparabrisas (90243394)

I



V-828

General Motors

Corsa/Corsa Wagon 1era serie. 1994-2010
Palanca de limpiaparabrisas y luneta

I



V-1427

Chevrolet

Corsa II / Meriva /
Agile palanca de luces y giros

N



V-818 A

General Motors

Corsa. 1994-2010. Llave rotativa
de luces con reostato tablero

I



V-818/IA

General Motors

Corsa base 1994-2010. Llave rotativa
de luces s/reostato tablero

I



V-1282

General Motors

C-20/D-20. Palanca
limpiaparabrisas

I



V-1283

General Motors

C-20/D-20. Palanca
de luces y giros

I



V-1286

General Motors

Astra hasta 1999
Llave rotativa de luces completa

I



V-1287

General Motors

Astra hasta 1999. Llave rotativa de
luces c/faros retronebla y reóstato

I



V-1288

General Motors

Astra hasta 1999
Llave rotativa de luces c/reóstato

I

Llaves conmutadoras de luces y l. parabrisas
Lights, wiper and horn control switches

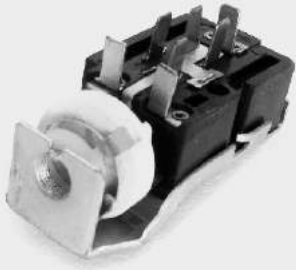

V-1347

General Motors

Automóviles/interruptor general de luces con reostato

I

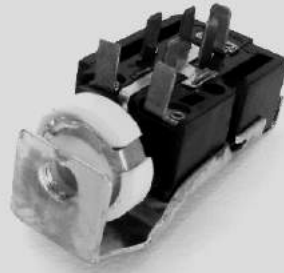

V-1348

General Motors

Pick-ups /interruptor general de luces con reostato

I



V-421

Ford

Galaxy -Palanca de luces y giros

I



V-422

Ford

Galaxy -Palanca de limpiaparabrisas

I



V-424

Ford

Sierra -Palanca de giros baliza y bocina

I



V-425

Ford

F-100 1993/1995 -Palanca de luces giros y guiñada

I



V-426

Ford

F-100 1993/1995 -Palanca de limpiaparabrisas

I

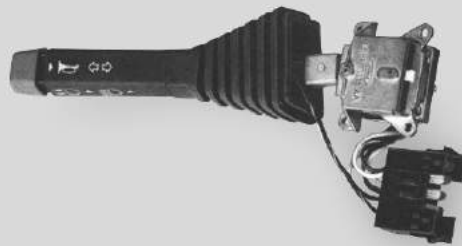

V-429

Ford

Camion Cargo -Palanca de luces giros y bocina

I



V-430

Ford

Camion Cargo -Palanca de limpiaparabrisas

I



V-595/1

Ford

Escort 1984-1995
Palanca luces, giro y baliza

N



V-432/1

Ford

Escort/Orion 1994-1995. Conmut. luces, baliza y l. parabrisas s/lavador tras.

N



V-433/1

Ford

Escort/Orion 1994-1995. Conmut. luces, baliza y l. parabrisas c/lavador tras.

N



V-434/1

Ford

N

Escort desde 1997. Conmutador luces, baliza y l. parabrisas c/lavador trasero



V-435/1

Ford

N

Fiesta/Ecosport/Ka desde 1996, Conmutador completo c/lavador trasero



V-436/1

Ford

N

Fiesta/Courier desde 1996. Conmutador completo s/lavador trasero



V-437/1

Ford

N

Ka hasta 2000. Conmutador luces y l. parabrisas c/lavador trasero



V-1222

Ford

I

Ranger-Explorer. Palanca luces y l. parabrisas



V-1234

Ford

I

Transit mod. viejo hasta 2000
Palanca luces, bocina y baliza



V-1235

Ford

I

Transit mod. viejo hasta 2000
Palanca luces y l. parabrisas doble



V-1236

Ford

I

Transit desde 2000.
Palanca luces simple. 23



V-1237

Ford

I

Transit desde 2000.
Palanca luces simple. 27

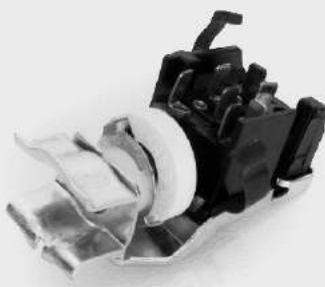

V-1340

Ford

I

Ford Falcon / F-100 / Camión
Interruptor general de luces



V-1341

Ford

I

Ford Falcon 1967/1972
Interruptor general de luces



V-1342

Ford

I

Ford Falcon 1968/1969
Interr. direccional de luces ygiros

Llaves conmutadoras de luces y l. parabrisas
Lights, wiper and horn control switches



V-1343

Ford

Ford Falcon 1969/1972
Interr. direccional de luces y giros



V-1344

Ford

Ford F-100 1968/1969
Interr. direccional de luces y giros



V-1345

Ford

Ford F-100 / F-350 hasta 1974
Interr. direccional de luces y giros



V-1346

Ford

Ford F-100 / F-350 1974/1979
Interr. direccional de luces y giros

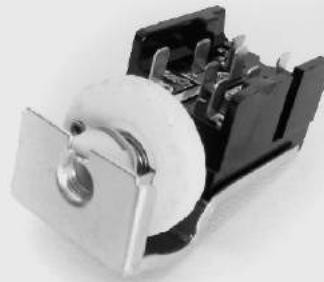

V-1349

Ford

Ford (reóstato grande)
Interruptor general de luces

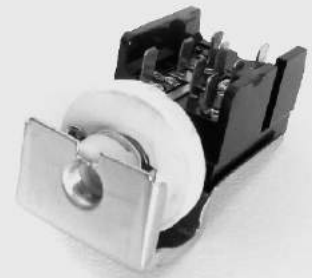

V-1350

Ford

Ford Fairline (reóstato grande)
Interruptor general de luces

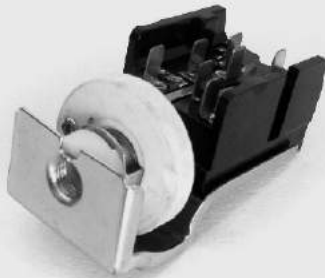

V-1351

Ford

Ford Falcon / doble faro (reóstato grande) Interr. gnal. de luces



V-1352

Ford

F. Falcon 1978/1980 c/ficha. Interr. direcc. de luces, giros y baliza



V-1353

Ford

F. Falcon 1980/1982. Interr. direcc. de luces, giros, baliza y guiño



V-1354

Ford

F-100/350 1981/1983 c/ficha. Interr. direcc. de luces, giros y baliza



V-1355

Ford

F-100/350 1979/1981. Interr. direcc. de luces, giros, baliza y guiño

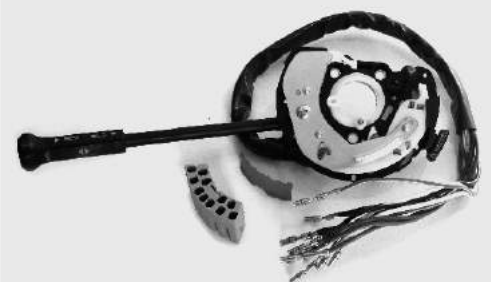

V-1356

Ford

F. Falcon 1982/1991 c/baliza, palanca y ficha. Interr. direcc. de luces y giros



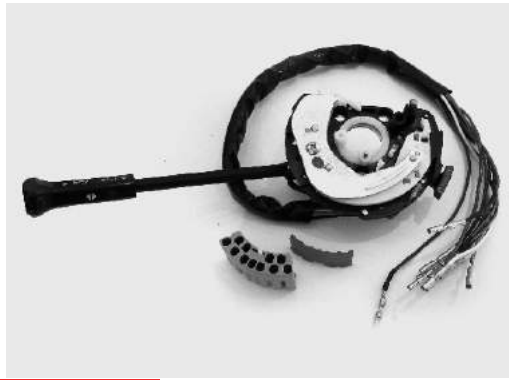

V-1357

Ford

F-100/350 1983/1991. Interr. direcc. de luces, giros, baliza c/palanca.



V-1358

Ford

Palanca de giro y guiño con bocina para V-1352/1353/1354/1355/1356



V-579

Volkswagen

Gol AB9 / Gol Country 1995/1999 Llave rotativa de luces c/neblinero



V-580

Volkswagen

Gol AB9 / Gol Country 1995/99 - Llave rot. de luces c/neblinero y retroniebla



V-581

Volkswagen

Polo / Caddy Palanca de luces y giros



V-589

Volkswagen

Gol AB9/Saveiro/Gol Country 1995-1999 Palanca luces, giro y balizas



V-586

Volkswagen

Gol AB9/Gol Country 1995/99 -Palanca de l.parabrisas y luneta



V-920

Volkswagen

Gol/Gol Country/Saveiro dde. 1999 Palanca de luces y giros



V-921

Volkswagen

Gol/Gol Country/Saveiro dde. 1999 Palanca de l.parabrisas y luneta



V-1083

Volkswagen

Gol/Gol Country/Saveiro dde. 1999 Llave rotativa de luces



V-1124

Volkswagen

Golf desde 1999 -Llave rotativa de luces c/neblinero



V-1218

Volkswagen

Golf IV / Bora desde 2000 Palanca de luces y giros



Llaves conmutadoras de luces y l. parabrisas
Lights, wiper and horn control switches



V-1219

Volkswagen

Golf IV/ Bora desde 2000. Palanca de luces y giros con computadora

I



V-583/1

Volkswagen

Pointer 1.6. Conmutador luces, baliza y l.parabrisas s/lavador trasero

N



V-584/1

Volkswagen

Pointer 1.8/2.0. Conmutador luces, baliza y l.parabrisas c/lavador trasero.

N



V-1363

Volkswagen

Gol Trend/ Fox/ Suran desde 2006
 Palanca de luces y giros (faros simples)

I



V-1364

Volkswagen

Gol Trend/ Fox/ Suran desde 2007
 Palanca de luces y giros (faros dobles)

I



V-1125

Volkswagen

Golf IV / Variant desde 2000
 Palanca limpiaparabrisas y luneta

I



V-1126

Volkswagen

Golf IV / Variant desde 2000. Palanca limpiaparabrisas y luneta c/comput.

I



V-1365

Volkswagen

Gol Trend/ Fox/ Suran desde 2004
 Palanca de limpiaparabrisas delantero

I



V-1366

Volkswagen

Gol Trend/ Fox/ Suran desde 2004.
 Palanca de l.parabrisas del. y trasero

I



V-1367

Volkswagen

Vento / Palanca de luces y giros c/comando computadora

I



V-42

Lada

Laika/Niva -Conmutador completo.3 conectores 6 , 4 y 2 vías

N

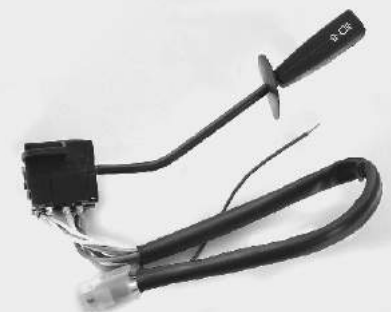

V-500

Scania

Scania 113
 Palanca de luces y giros

I



V-501

Scania

Scania 113
Palanca de l. parabrisas



V-596

Seat

Ibiza / Córdoba 1993-2000
Palanca luces, giro y baliza



V-1334

Suzuki

Fun / Completo de luces y limpia-
parabrisas c/lavador trasero y baliza



Fiat

Peugeot

Renault

Mercedez Benz

Ford

Volkswagen

Iveco

Universal

General Motors

Dodge

John Deere

Massey Ferguson

Zanello

Deutz Fahr

Yale





V-50

N

Fiat

Fiorino nafta/diesel hasta 1995 - 2 tubos
(Ω) vacío: 290-310 / lleno: 0-10



V-51

N

Fiat

600 todas las versiones - 1 tubo
(Ω) vacío: 5-10 / lleno: 85-90



V-52

N

Fiat

125 todas las versiones - 2 tubos
(Ω) vacío: 280-300 / lleno: 0-10



V-53

N

Fiat

128 primera serie - 2 tubos
(Ω) vacío: 280-300 / lleno: 0-10



V-54

N

Fiat

128 Europa y Supereuropa 2 tubos c/pist.
(Ω) vacío: 280-300 / lleno: 0-10



V-55

N

Fiat

133 todas las versiones - 1 tubo
(Ω) vacío: 280-300 / lleno: 0-10



V-56

N

Fiat

147 version brasileru s/pist. - 2 tubos
(Ω) vacío: 280-300 / lleno: 20-30



V-57

N

Fiat

147 / Spazio / Vivace - 2 tubos c/piston
(Ω) vacío: 280-300 / lleno: 20-30



V-58

N

Fiat

1500 todas las versiones - 1 tubo
(Ω) vacío: 5-10 / lleno: 85-90



V-68

N

Fiat

Regatta todas las vers. - 2 tubos c/pist.
(Ω) vacío: 280-300 / lleno: 0-10



V-70

N

Fiat

Duna / Uno hasta 1993. Todos a bayoneta
(Ω) vacío: 280-300 / lleno: 0-10



V-70/1

N

Fiat

Duna/Uno, 1993-2000. Nafta a tornillos
(Ω) vacío: 280-300 / lleno: 0-10

Sensores de nivel de combustible
Fuel level senders



V-70/2

Fiat

N

Duna/Uno 1993-2000. Diesel a tornillos
(Ω) vacío: 280-300 / lleno 0-10



V-70/3

Fiat

N

Uno ital. 70 S motor carbur.-a bayoneta
(Ω) vacío: 280-300 / lleno: 0-10

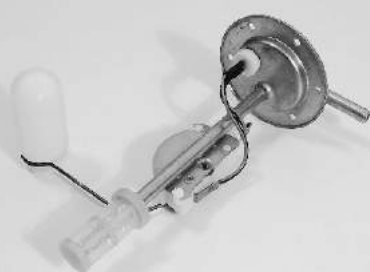

V-239

Fiat

N

Ducato primera serie - 1 tubo
(Ω) vacío: 300-320 / lleno: 20-30



V-240

Fiat

N

Ducato segunda serie - 2 tubos
(Ω) vacío: 300-320 / lleno: 20-30



V-240/1

Fiat

N

Ducato seg. s. TD 2.5-2.8 largo, 2 tubos
(Ω) vacío: 300-320 / lleno: 20-30



V-66

Fiat

N

Camion Fiat Iveco c/piston
(Ω) vacío: 280-300 / lleno: 0-10



V-251

Fiat

N

Palio/Siena/Weekend 1996-2000. Nafta
(Ω) vacío: 270-290 / lleno 35-45



V-1194

Fiat

N

Palio/Siena/Weekend desde 2000. Nafta
(Ω) vacío: 350-370 / lleno 60-70



V-1263

Fiat

N

Uno.Todos c/sist inyecc. desde 2000
Naft. IE/MP (Ω) vacío: 400-420 / lleno 50-55



V-1411

Fiat

N

Uno Fire m. naftero/diesel desde 2004
(Ω) vacío: 360 / lleno: 65



V-1412

Fiat

N

Fiorino Fire m. naftero/diesel desde 2003
(Ω) vacío: 360 / lleno: 65

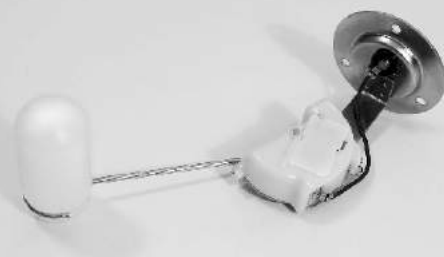

V-59

Peugeot

N

504 Primera serie
(Ω) vacío 280-310 / lleno: 0-10



V-60

Peugeot

N

404 Todos
(Ω) vacío 280-310 / lleno: 0-10



V-61

Peugeot

N

504 T5
(Ω) vacío 280-310 / lleno: 0-10



V-61/I

Peugeot

N

504 T5 Pick-up desde 1993 c/piston
(Ω) vacío 280-310 / lleno: 0-10



V-62

Peugeot

N

505 c/piston
(Ω) vacío 280-310 / lleno: 0-10



V-62/I

Peugeot

N

504 Largo - 504 auto c/piston
(Ω) vacío 280-310 / lleno: 0-10



V-240

Peugeot

N

Boxer - 2 tubos
(Ω) vacío. 300-320 / lleno: 20-30



V-240/I

Peugeot

N

Boxer - largo 2 tubos
(Ω) vacío. 300-320 / lleno: 20-30



V-314

Peugeot

I

405 motor diesel 1.8-1.9



V-315

Peugeot

I

305 motor diesel 1.9



V-316

Peugeot

I

206 motor diesel 1.9 DWB



V-317

Peugeot

I

205 motor diesel/nafta

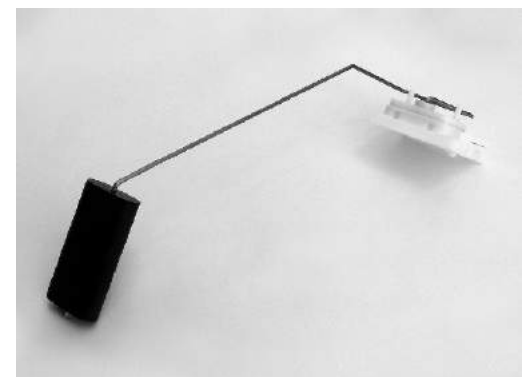

V-1409

Peugeot

I

206 motor naftero 1.6/1.4, 2000/2006
(Ω) vacío: 340 lleno: 15

Sensores de nivel de combustible
Fuel level senders

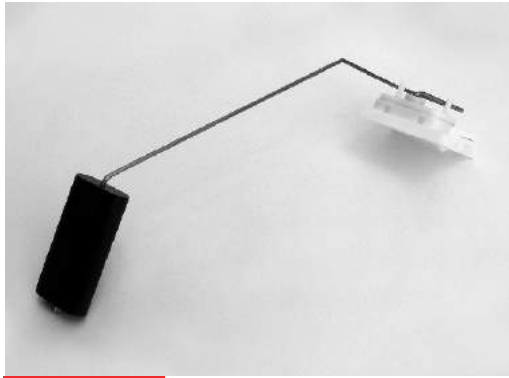

V-1410

Peugeot

I

307 motor naftero 1.6/2.0 desde 2006
(Ω) vacío: 350 / lleno: 50



V-201

Renault

N

12 todas las versiones
(Ω) vacío: 280-310 / lleno: 0-10



V-1428

Renault

N

4 y 4L todos los modelos
(Ω) vacío: 80 / lleno: 3



V-1429

Renault

N

4S y 4F Furgón
(Ω) vacío: 300 / lleno: 10



V-1430

Renault

N

6 todos los modelos
(Ω) vacío: 300 / lleno: 10



V-202

Renault

N

18 version sin tubos
(Ω) vacío: 280-300 / lleno: 0-10



V-203

Renault

N

18 con 2 tubos version gtx
(Ω) vacío: 280-300 / lleno: 0-10



V-204

Renault

N

18 diesel 2 tubos
(Ω) vacío: 280-300 / lleno: 0-10



V-205

Renault

N

18 break 2 tubos
(Ω) vacío: 280-300 / lleno: 0-10



V-206

Renault

N

Fuego todas las versiones 2 tubos
(Ω) vacío: 280-300 / lleno: 0-10



V-207

Renault

N

9 / 11 / 19 RN-RT motor carburado
(Ω) vacío: 280-300 / lleno: 0-10



V-208

Renault

N

Trafic nafta todas las versiones
(Ω) vacío: 280-300 / lleno: 0-10



V-209

Renault

Trafic diesel todas las versiones
(Ω) vacío: 280-300 / lleno: 0-10

N

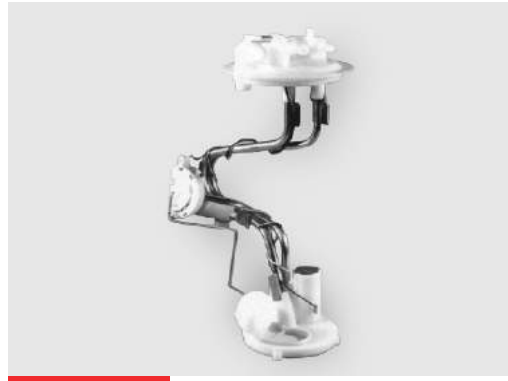

V-311

Renault

19 desde 1993
Motor nafta 1.7 mpi

I



V-1360

Renault

Clio 1994-1999
Motor nafta 1.4-1.6 y motor diesel 1.9

I



V-1361

Renault

Clio 2 desde 2000 motor diesel 1.5 DCI

I



V-1362

Renault

Kangoo 1998-2010
Motor diesel 1.9

I



V-1407

Renault

Clio II motor naftero 1.2/1.6 desde 2000
(Ω) vacío: 300 / lleno: 5

I

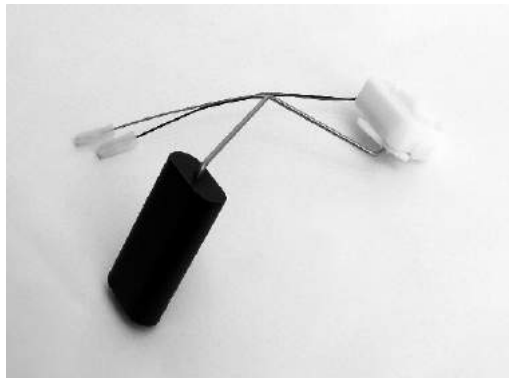

V-1408

Renault

Megane/Scenic
m. naftero 1.6/2.0 desde 2000
(Ω) vacío: 300 / lleno: 5

I

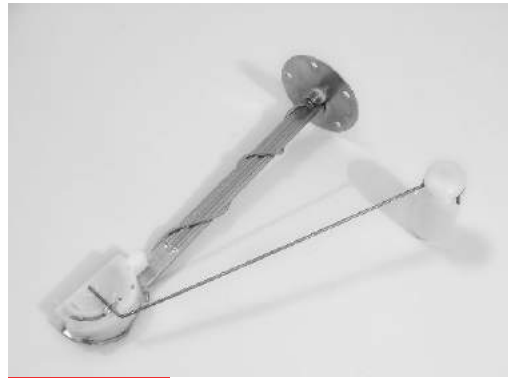

V-210

Mercedes Benz

Camión 1112-1114-1214-1517 todos
(Ω) vacío: 70-80 / lleno: 0-5

N



V-211

Mercedes Benz

Camión 608 - corto
(Ω) vacío: 70-80 / lleno: 0-5

N



V-212

Mercedes Benz

Camión 608 - largo
(Ω) vacío: 70-80 / lleno: 0-5

N



V-49

Ford

Falcon todos - tubo 1962/1982
(Ω) vacío: 70-80 / lleno: 3-10

N



V-220

Ford

F-100 Diesel todos desde 1992
(Ω) vacío: 80-90 / lleno: 0-5

I

Sensores de nivel de combustible
Fuel level senders



V-248

Ford

N

Galaxy inyecc. dde 1993 sólo medidor
(Ω) vacío: 280-300 / lleno: 35-40



V-249

Ford

N

Escort / Orion 1994/1997 solo medidor
(Ω) vacío: 280-300 / lleno: 35-40

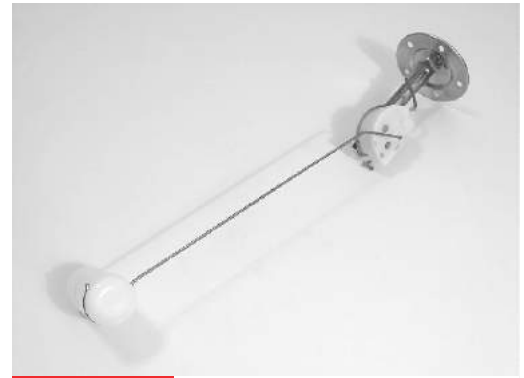

V-261

Ford

N

F-100 / F-250 nft/dsl 1961/81 brida 5 orif.
(Ω) vacío: 70-80 / lleno: 3-10



V-279

Ford

N

F-100 nafta 1981/86 5 v
(Ω) vacío: 70-80 / lleno: 3-10



V-280

Ford

N

F-100 diesel 1981/86 5 v - 2 tubos
(Ω) vacío: 70-80 / lleno: 3-10

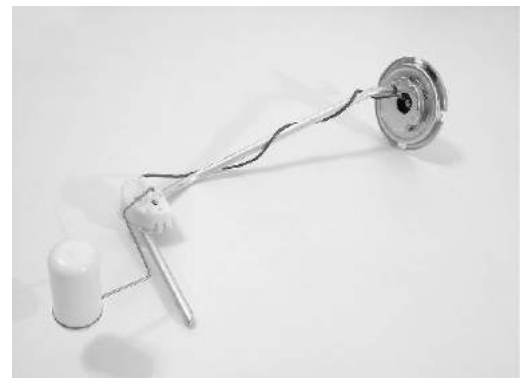

V-262

Ford

N

F-100 nafta desde 1986 10 v - 1 tubo
(Ω) vacío: 230-270 / lleno: 10-20



V-263

Ford

N

F-100 diesel 1986/1992 10 v - 2 tubos
(Ω) vacío: 230-270 / lleno: 10-20



V-264

Ford

N

Taurus 1984 5 v - 1 tubo
(Ω) vacío: 230-270 / lleno: 10-20



V-265

Ford

N

Taurus 1980 - 2 tubos
(Ω) vacío: 70-80 / lleno: 3-10



V-266

Ford

N

Falcon 1982/1986 5v c/piston
(Ω) vacío: 70-80 / lleno: 3-10



V-267

Ford

N

Falcon 1986 10v c/piston
(Ω) vacío: 230-270 / lleno: 10-20



V-268

Ford

N

Falcon diesel 1988 10v 2 tubos
(Ω) vacío: 230-270 / lleno: 10-20



V-277

Ford

N

Sierra L-GL 2 tubos
(Ω) vacío: 230-270 / lleno: 10-20



V-278

Ford

N

Sierra Chia - Chia S - XR4 c/ check panel
(Ω) vacío: 230-270 / lleno: 10-20



V-1431

Ford

N

Escort Chia, 1988-1994. LK-SX
Tapa grande (Ω) vacío: 250 / lleno: 20

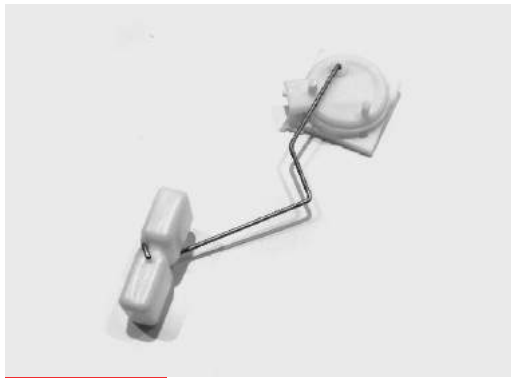

V-1260

Ford

N

Fiesta nuevo / Ecosport 4x2 nafta
(Ω) vacío: 10-15 / lleno: 150-170

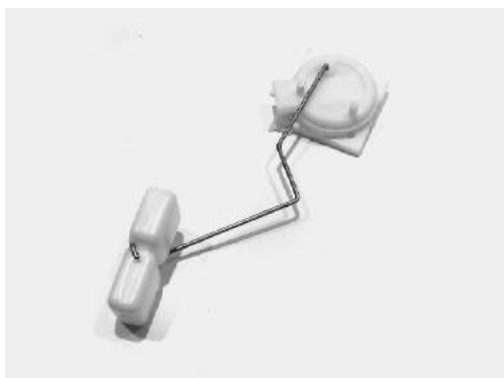

V-1268

Ford

N

Courier nafta
(Ω) vacío: 140.150 / lleno: 18-22



V-1278

Ford

N

Focus naftero desde 2000
(Ω) vacío: 10-15 / lleno: 150-170



V-1404

Ford

I

Escort motor naftero 1.6/1.8 1996/2003
(Ω) vacío: 140 / lleno: 20



V-1405

Ford

I

Fiesta/Ka motor naftero 1.0/1.6 1996/2003
(Ω) vacío: 140 / lleno: 20



V-1406

Ford

I

Ranger motor diesel 3.0 desde 2003
(Ω) vacío: 15 / lleno: 160



V-247

Volkswagen

N

Gol AB9/Gol Country 1994-1996. Nafta
(Ω) vacío: 280-300 / lleno: 35-40



V-248

Volkswagen

N

Santana Quantum desde 1993. Inyecc.
(Ω) vacío: 280-300 / lleno: 35-40



V-249

Volkswagen

N

Pointer 1994-1997. Inyección

Sensores de nivel de combustible
Fuel level senders



V-271

Volkswagen

1500 hasta 1977. Sin espía de reserva
(Ω) vacío: 290-310 / lleno: 5-10

N



V-272

Volkswagen

1500 hasta 1977. Con espía de reserva
(Ω) vacío: 290-310 / lleno: 5-10

N



V-273

Volkswagen

1500 desde 1978 hasta 1986
(Ω) vacío 290-310 / lleno: 5-10

N



V-274

Volkswagen

1500 1978 en adelante
(Ω) vacío 230-270 / lleno: 20-30

N



V-275

Volkswagen

Gacel 1983/1989 sin espía de reserva
(Ω) vacío 250-300 / lleno: 20-30

N



V-276

Volkswagen

Gacel 1983/1989 con espía de reserva
(Ω) vacío 250-300 / lleno: 20-30

N



V-1400

Volkswagen

Golf III Country III
motor naftero 1.6 desde 2000.
(Ω) vacío: 290 / lleno: 40

I

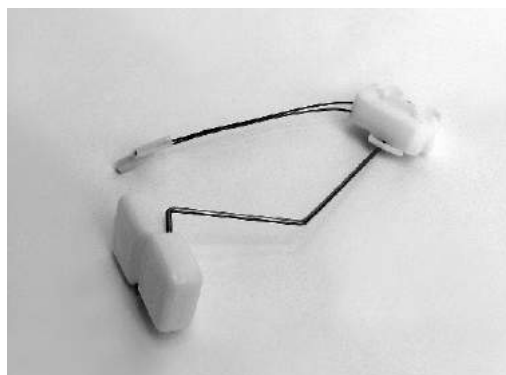

V-1401

Volkswagen

Saveiro motor naftero 1.6 desde 2000.
(Ω) vacío: 285 / lleno: 40

I

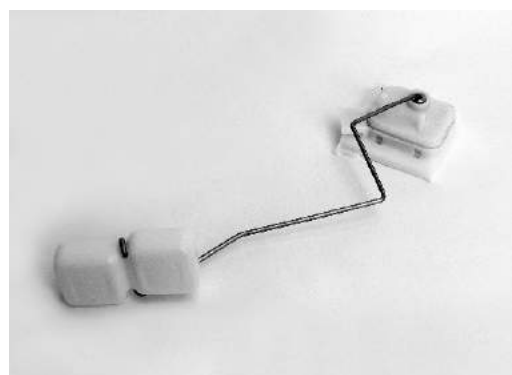

V-1402

Volkswagen

Fox/Suran/Crossfox
motor naftero 1.6 desde 2003
(Ω) vacío: 280 / lleno: 40

I

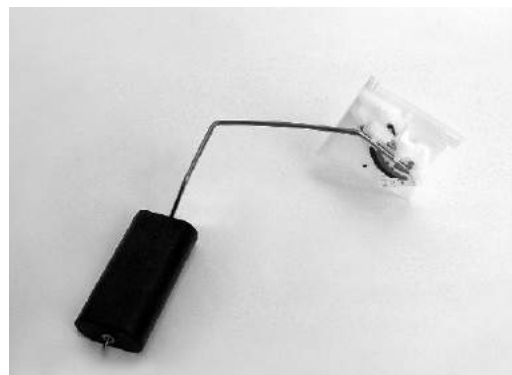

V-1403

Volkswagen

Golf IV / Bora / A3
motor naftero 1.6-2.0 desde 2000
(Ω) vacío: 50 / lleno: 280

I

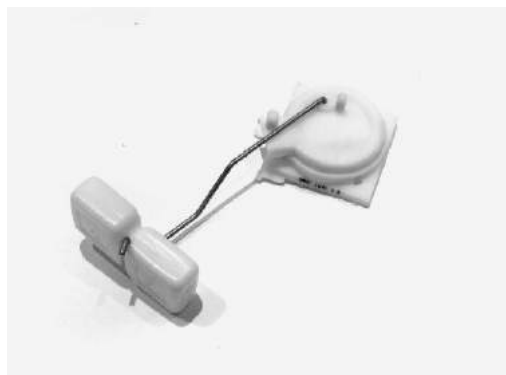

V-227

General Motors

Corsa 1994-1999 motor naftero/diesel
(Ω) vacío: 270-290 / lleno: 35-45

N



V-229

General Motors

Vectra desde 1996 motor naftero
(Ω) vacío: 270-290 / lleno: 35-45

N



V-1261

General Motors

Corsa 1999-2001 motor naftero
(Ω) vacío: 270-290 / lleno: 35-45

N



V-1266

General Motors

Corsa desde 2003 motor naftero
(Ω) vacío: 270-290 / lleno: 35-45

N



V-1267

General Motors

Astra desde 1998 motor naftero
(Ω) vacío: 270-290 / lleno: 35-45

N

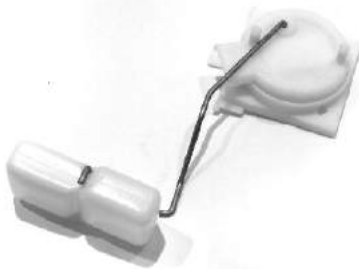

V-1275

General Motors

Astra / Zafira dde 1999 motor naftero
(Ω) vacío: 270-290 / lleno: 35-45

N



V-1276

General Motors

Astra / Zafira dde 1999 motor naftero
(Ω) vacío: 270-290 / lleno: 35-45

N



V-222

General Motors

Pick-up C-20/D-20 (tq. 84 lbs)
(Ω) vacío: 0-5 / lleno: 85-90

I



V-223

General Motors

Pick-up C-20/D-20 (tq. 104 lbs)
(Ω) vacío: 0-5 / lleno: 85-90

I



V-224

General Motors

Pick-up C-20/D-20/Silverado (tq. 125 lbs)
(Ω) vacío: 0-5 / lleno: 85-90

I



V-1432

General Motors

Monza desde 1990
(Ω) vacío: 3 / lleno: 90

N

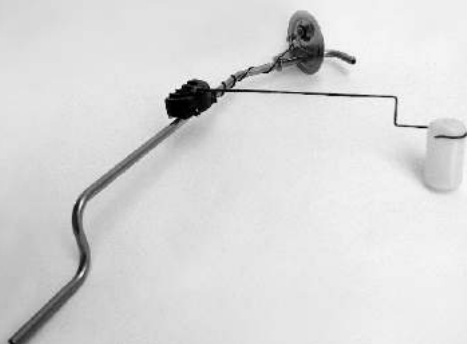

V-1433

Dodge

Pick-up motor naftero 1961/1981
(Ω) vacío: 70 / lleno: 9

N



V-1374

Universal

Máquinaria-autoelevadores-náutica
(Ω) vacío: 70-80 / lleno: 3-10

N



V-1375

Universal

Máquinaria-autoelevadores-náutica
(Ω) vacío: 0-10 / lleno: 100

N



V-1376

Universal

Máquinaria-autoelevadores-náutica
(Ω) vacío 280-310 / lleno: 0-10

N

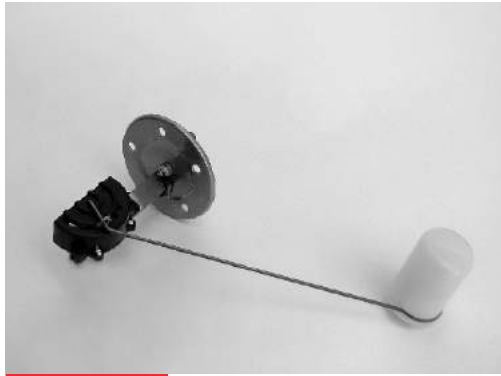

V-1434

John Deere

Modelo 730
(Ω) vacío: 0 / lleno: 30

N

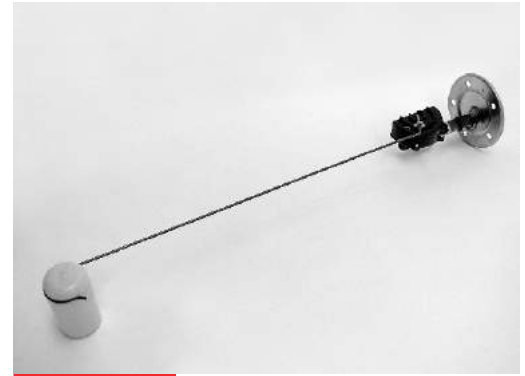

V-1435

John Deere

Modelo 1420-2420-3420-4420-
3330-3530-4530
(Ω) vacío: 300 / lleno: 5

N

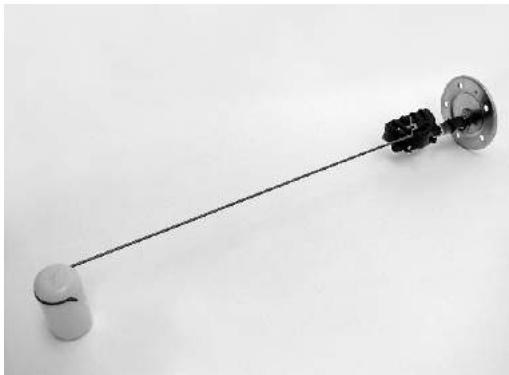

V-1436

John Deere

Modelo 2330-230-2730
(Ω) vacío: 300 / lleno: 5

N



V-1437

John Deere

Modelo 3140
(Ω) vacío: 10 / lleno: 180

N

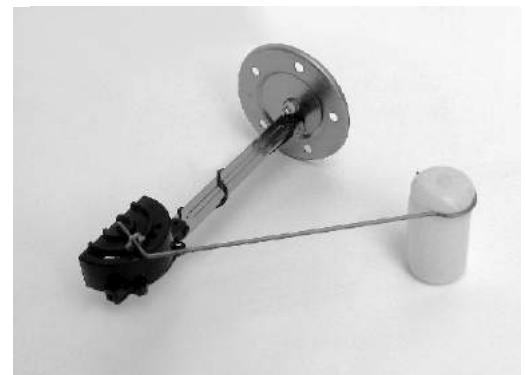

V-1438

Massey Ferguson

Modelo 150-155-165-265-1075-1078
1088-1095-1175 tanque superior
(Ω) vacío: 3 / lleno: 100

N

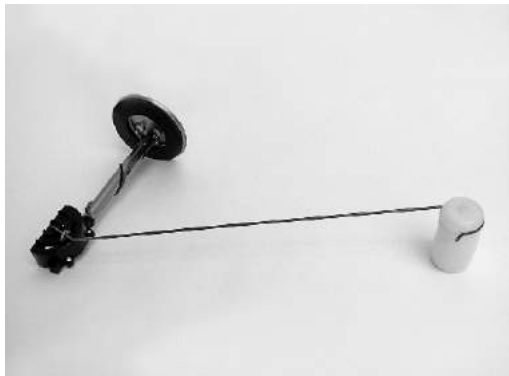

V-1439

Massey Ferguson

Modelo 1185-1195-1215-5140-5160-5190
1475-1485-1499 tanque lateral
(Ω) vacío: 3 / lleno: 100

N

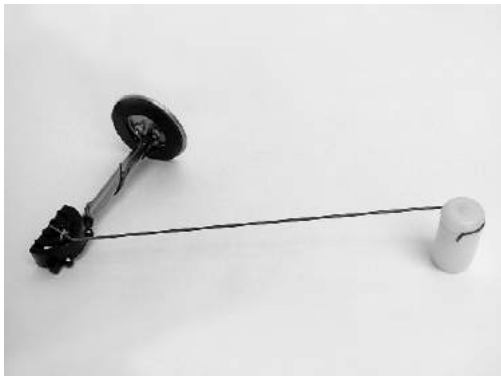

V-1440

Massey Ferguson

Modelo 1615-1640-1660-1680 desde 1994
(Ω) vacío: 300 / lleno: 3

N

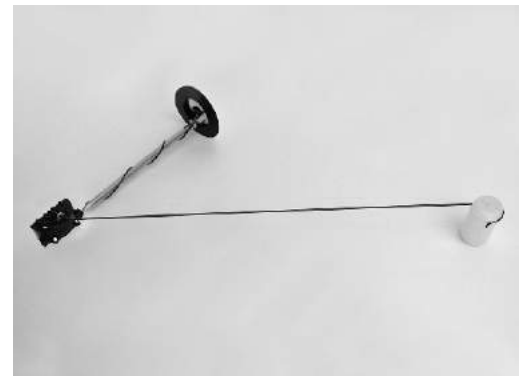

V-1441

Zanella

Modelo V206-M415D-M413F (óptico)
(Ω) vacío: 300 / lleno: 7

N

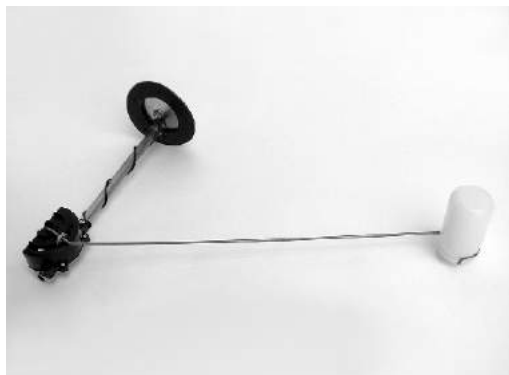

V-1442

Zanella

Modelo V206-M415D-M413F
(Ω) vacío: 300 / lleno: 7

N

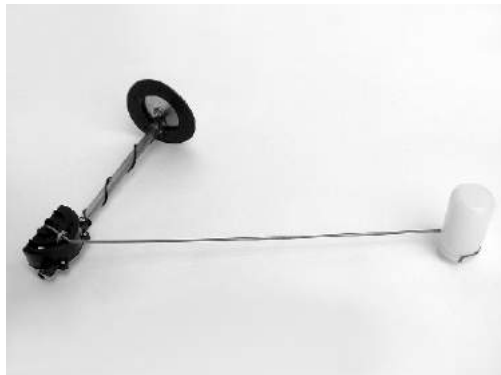

V-1443

Zanella

Modelo V206-M415D-M413F
con testigo de reserva
(Ω) vacío: 300 / lleno: 7

N

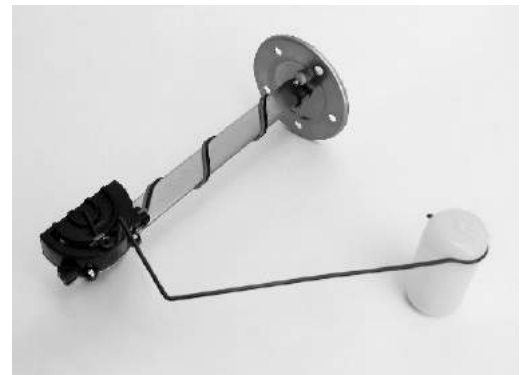

V-1444

Deutz Fahr

Modelo AX80-100-120 / AX4-100-120-140
(Ω) vacío: 300 / lleno: 2

N

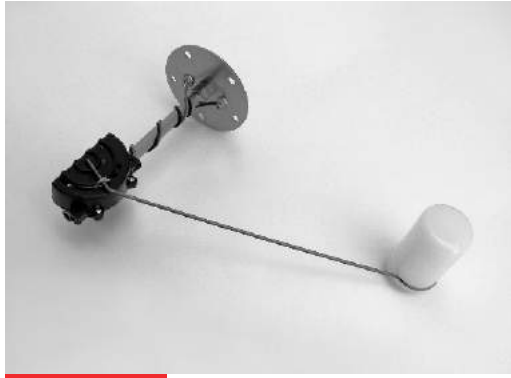

V-1445

Deutz Fahr

Modelo AX120 tanque superior
(Ω) vacío: 300 / lleno: 10

N



V-1446

Deutz Fahr

Modelo AX160 tanque superior
(Ω) vacío: 300 / lleno: 10

N

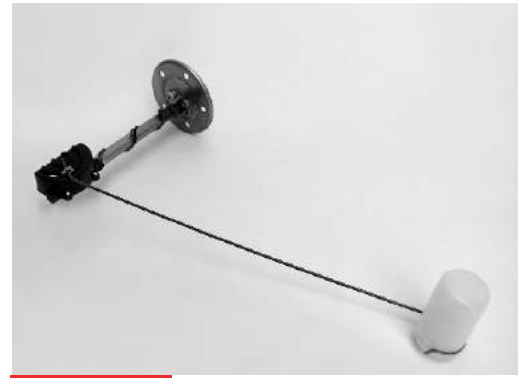

V-1447

Deutz Fahr

Modelo AX160 tanque inferior
(Ω) vacío: 300 / lleno: 10

N



V-1448

Yale

Autoelevador
(Ω) vacío: 300 / lleno: 7

N

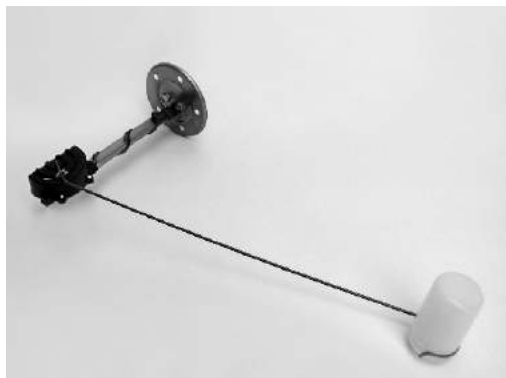

V-1449

Yale

Autoelevador
(Ω) vacío: 300 / lleno: 7

N

Fiat

Peugeot

Renault

Citröen

Mercedez Benz

General Motors

Ford

Volkswagen

Iveco

Suzuki

Toyota





V-502

Fiat

Regatta - tecla alzacristal simple



V-506

Fiat

Duna / Uno . 1995-2003
Tecla alzacristal simple



V-507

Fiat

Duna / Uno . 1995-2003
Tecla alzacristal doble



V-506/1

Fiat

Duna / Uno . 1995-2003
Tecla alzacristal simple sin marco



V-507/1

Fiat

Duna / Uno . 1995-2003
Tecla alzacristal doble sin marco



V-508

Fiat

Uno / Duna Weekend desde 1995
tecla lava luneta



V-509

Fiat

Duna / Uno desde 1995
tecla faro caminero/auxiliar



V-510

Fiat

Duna / Uno desde 1995
tecla faro retroneblia



V-511

Fiat

Duna / Uno / Fiorino . 1995-2003
Tecla baliza



V-512

Fiat

Duna / Uno desde 1995
tecla aires acondicionado



V-513

Fiat

Tipo todas las versiones
tecla baliza



V-514

Fiat

Ducato hasta 1999
tecla baliza cuadrada





V-515

Fiat

Ducato hasta 1999
tecla faros neblineros

I



V-536

Fiat

Spazio todos / Duna / Uno. 1988-1994
Tecla baliza

I



V-544

Fiat

Palio / Siena . 1996-2000
Tecla faro neblinero

I



V-545

Fiat

Palio / Siena. 1996/2000
Tecla faro retroniebla

I



V-546

Fiat

Palio / Siena. 1996/2000
Tecla luneta térmica

I



V-547

Fiat

Spazio / 147 / 128 Europa
tecla luces 2 puntos

N



V-843

Fiat

Palio / Siena Lujo. 1996/2000
Alzacristal doble

I



V-844

Fiat

Palio / Siena Lujo. 1996/2000
Alzacristal simple

I



V-845

Fiat

Palio / Siena base. 1996/2000
Alzacristal doble

I



V-846

Fiat

Palio / Siena base. 1996/2000
Alzacristal simple

I



V-956

Fiat

128 Europa y Super Europa
tecla alzacrystal

N



V-957

Fiat

128 Europa y 125 Mirafiori
tecla calefactor 2 veloc.

N



V-958

Fiat

128 Europa y 125 Mirafiori
tecla luneta termica

N



V-959

Fiat

128 Europa, Super Europa y 147
tecla baliza

N



V-1142

Fiat

Palio / Siena . 1996-2000
Tecla baliza

I



V-1170

Fiat

Palio / Siena. 2000/2004. Tecla
alzacristal simple delantera derecha

I



V-1171

Fiat

Palio / Siena. 2000/2004. Tecla
alzacristal simple delantera izquierda

I



V-1172

Fiat

Palio / Siena. 2000/2004. Tecla
alzacristal simple trasera derecha

I



V-1173

Fiat

Palio / Siena. 2000/2004. Tecla
alzacristal simple trasera izquierda

I



V-484

Fiat

Ducato desde 1999
tecla baliza

I



V-485

Fiat

Ducato desde 1999
tecla faro retroneblia

I



V-486

Fiat

Ducato desde 1999
tecla faro neblinero

I



V-487

Fiat

Ducato desde 1999
tecla sirena / avisador

I



V-488

Fiat

Ducato desde 1999
tecla luz de cabina

I



V-489

Fiat

Ducato desde 1999
tecla aire acondicionado



V-1330

Fiat

Palio/Siena 1996/2000 tecla
alza vidrio simple sin marco



V-1331

Fiat

Palio/Siena 1996/2000 tecla
alza vidrio doble sin marco



V-1388

Fiat

Palio/Siena desde 2004
Tecla alzacristal simple con marco



V-1389

Fiat

Palio/Siena desde 2004
Tecla alzacristal doble con marco



V-1390

Fiat

Palio/Siena desde 2004
Tecla alzacristal cuádruple con marco



V-1391

Fiat

Punto/Linea tecla alzacristal
simple con marco



V-1392

Fiat

Punto/Linea tecla alzacristal doble
con marco + control espejos



V-1393

Fiat

Punto/Linea tecla alzacristal cuádruple
con marco + control espejos



V-1415

Fiat

Uno nuevo desde 2010
Tecla alzacristal simple izquierda



V-1416

Fiat

Uno nuevo desde 2010
Tecla alzacristal simple derecha



V-1417

Fiat

Palio/Siena Fire. 2001-2006
Tecla baliza + luneta térmica





V-1418

Fiat

Palio/Siena Fire, 2001-2006. Tecla baliza + luneta térmica + faros auxiliares

I



V-514

Peugeot

Boxer hasta 1999
tecla baliza rectangular

I



V-515

Peugeot

Boxer hasta 1999
tecla faros neblineros

I



V-523

Peugeot

405, 1993-2000 / 106 todos
Tecla alzacristal simple

N



V-524

Peugeot

405, 1993-2000 / 106 todos
Tecla alzacristal simple secuencial

I



V-531

Peugeot

306 hasta 1998
tecla alzacristal simple

N



V-532

Peugeot

306 hasta 1998
tecla alzacristal simple secuencial

I



V-533

Peugeot

306 desde 1998
tecla baliza

I



V-534

Peugeot

206 / 306 desde 1998
tecla doble alzacristal

I



V-534/I

Peugeot

206 / 306 desde 1998. Tecla doble alzacristal (I secuencial)

I



V-535

Peugeot

206 / 306 desde 1998. Tecla doble alzacristal c/control espejos

I



V-535/I

Peugeot

206 / 306 dde. 98'. Tecla doble alzacristal (I secuencial) c/ctrl. espejos

I



V-964

Peugeot

504 GR II. Tecla
alzacristal simple

N



V-965

Peugeot

504 SR desde 1991. Tecla
alzacristal simple

N



V-966

Peugeot

504 GR II
tecla calefactor 2 veloc.

N



V-967

Peugeot

504 1991/1993
tecla baliza iluminada

N



V-968

Peugeot

504 SR desde 1993. Tecla
baliza iluminada

N



V-969

Peugeot

504 SR desde 1993. Tecla luneta
térmica iluminada

N



V-970

Peugeot

504 SR desde 1993. Tecla
faro retroniebla

N



V-971

Peugeot

504 SR desde 1993
tecla luces iluminada verde

N



V-1040

Peugeot

Partner hasta 2010 / 406
Tecla alzacristal simple

I



V-1041

Peugeot

Partner hasta 2010 / 406
Tecla alzacristal simple secuencial

I



V-1042

Peugeot

Partner hasta 2010 todas las versiones
Tecla baliza

I



V-1079

Peugeot

505 / 205 / 309 / 405 hasta 1993
Tecla alzacristal simple

N



V-484

Peugeot

Boxer desde 1999
Tecla baliza

I



V-485

Peugeot

Boxer desde 1999
Tecla retronebla

I



V-486

Peugeot

Boxer desde 1999
Tecla faro neblinero

I



V-487

Peugeot

Boxer desde 1999
Tecla sirena / avisador

I



V-488

Peugeot

Boxer desde 1999
Tecla luz de cabina

I



V-519

Peugeot

405. 1993-2000
Tecla baliza iluminada 9f

I



V-520

Peugeot

405. 1993-2000
Tecla luneta térmica

I



V-522

Peugeot

405. 1993-2000
Tecla faro retronebla

I



V-1158

Peugeot

307 todos
Tecla baliza

N



V-1071

Peugeot

206 tecla baliza simple desde 2003

I



V-1071/1

Peugeot

206 desde 2003.
Tecla baliza y cierre centralizado

I



V-1370

Peugeot

207 tecla alzacristal doble
color metalizado

I



V-1371

Peugeot

207 tecla alzacristal doble con una secuencial color metalizado

I



V-1372

Peugeot

207 tecla alzacristal doble + control espejos color metalizado

I



V-1373

Peugeot

207 tecla alzacristal doble con una secuencial + control espejos color metalizado

I



V-1053

Renault

Clio Primera serie. 1994-1999
Tecla faro neblinero

I



V-1057

Renault

Clio Primera serie. 1994-1999
Tecla baliza

N



V-1054

Renault

Clio Primera serie. 1994-1999
Tecla alzacristal simple

N



V-1279

Renault

Clio Primera serie. 1994-1999
Tecla alza cristal simple 6T

N



V-1058

Renault

19 desde 1993. Tecla alzacristal simple 5 terminales

N



V-1059

Renault

19 desde 1993. Tecla alzacristal simple 6 terminales

N



V-1069

Renault

19 desde 1993
Tecla baliza

N



V-1089

Renault

Kangoo / Kangoo Express
Tecla baliza

I



V-1252

Renault

Express. Llave tecla baliza iluminada 9 terminales.

N



V-1052

Renault

9-11-18 primera serie
Tecla baliza

N



V-1063

Renault

Clio/Megane/Kangoo desde 2000
Tecla alzacristal simple secuencial

I



V-1078

Renault

12 modelo nuevo
Tecla baliza / terminales finos

I



V-1302

Renault

21 desde 1993
Tecla baliza

N



V-1303

Renault

21 desde 1993. Tecla alzacristal
simple 5T

N



V-1304

Renault

21 desde 1993. Tecla alzacristal
simple 6T

N



V-1311

Renault

Scenic dde. 1999. Tecla alzacrist. simple
6 t. pta der. Gris claro.

N



V-1312

Renault

Megane h. 1999. Tecla alzacrist. simple
5 t. pta. izq. Gris oscuro.

N



V-1313

Renault

Megane-Clio 2 dde. 1999. Tecla alzacrist.
simple 5 t. pta. izq. Gris osc.

N



V-1314

Renault

Megane dde. 1999. Tecla alzacrist. simple
5 t. pta. izq. Negro.

N



V-1315

Renault

Megane h. 1999. Tecla alzacrist. simple
5 t. pta. izq. Gris oscuro.

N



V-1316

Renault

Megane dde. 1999. Tecla alzacrist. simple
6 t. pta. der. Gris oscuro.

N



V-1317

Renault

N

Clio 2 dde. 1999. Tecla alzacrist. simple 5 t. pta. izq. Gris claro.



V-1318

Renault

N

Megane-Kangoo h. 1999. Tecla alzacrist. simple 6 t. pta. der. Gris osc.



V-1319

Renault

N

Megane-Clio 2 dde. 1999. Tecla alzacrist. simple 6 t. pta. der. Gris osc.



V-1320

Renault

N

Megane dde. 1999. Tecla alzacrist. simple 6 t. pta. der. Gris oscuro.



V-1321

Renault

N

Twingo dde. 1998. Tecla alzacrist. simple 5 t. pta. izq. Amarillo.



V-1322

Renault

N

Twingo dde. 1998. Tecla alzacrist. simp. 6 ter. pta. der. Amarilla.



V-1323

Renault

N

Twingoh. 1996. Tecla alzacristal simple 5 term. pta. izq. Azul.



V-1324

Renault

N

Twingo h. 1996. Tecla alzacristal simple 6 term. pta. der. Azul.



V-1153

Renault

I

9/11/18
Tecla lazacristal simple 5T



V-1262

Renault

I

Clio 2 2000/2006
Tecla baliza



V-1146

Renault

I

Megane / Scenic
Tecla baliza



V-1295

Renault

I

9-11-18 segunda serie. Tecla baliza (cuadrada tipo push)



V-1294

Renault

Trafic 1986-1996
Tecla baliza

I



V-1297

Renault

9-11-18
Tecla cierre centralizado

I



V-1298

Renault

09-11-18
Tecla luneta termica

I



V-1301

Renault

19 dde. 1993 / Master. Tecla
alzacristal secuencial

I



V-1337

Renault

Megane 2 / Laguna 2 / Master
Línea nueva tecla baliza iluminada

I



V-1368

Renault

Stepway / Sandero / Logan hasta 2011
Tecla alzavidrio simple

N



V-1385

Renault

Megane II tecla alzacristal doble
lado conductor

I



V-1040

Citröen

Berlingo / Xantia
Tecla alzacristal simple

I



V-1041

Citröen

Berlingo / Xantia
Tecla alzacristal simple secuencial

I



V-1042

Citröen

Berlingo
Tecla baliza

I



V-1414

Mercedes Benz

Sprinter tecla aire acondicionado

I



V-1421

Mercedes Benz

Camiones/omnibus desde 1988
tecla baliza roja 24V

I



V-981

Mercedes Benz

Camion / Omnibus
Tecla limpiaparabrisas

N



V-982

Mercedes Benz

Camion / Omnibus
Tecla calefactor

N



V-983

Mercedes Benz

Camion / Omnibus
Tecla luz de cabina

N



V-984

Mercedes Benz

Camion / Omnibus
Tecla luces 2 puntos

N



V-985

Mercedes Benz

Camion
Tecla lava y limpia luneta

N



V-804

General Motors

D-20 / C-20
Tecla alzacrystal simple

I



V-806

General Motors

Camion D-20
Tecla baliza redonda

I



V-807

General Motors

Corsa 1994 / 2001
Tecla baliza sin piloto alarma

I



V-810

General Motors

Monza / Kadett / C-20 dde. 1993
Tecla baliza redonda

I



V-820

General Motors

Chevrolet C20 / D20
Conmutador rotativo de luces

I



V-807/I

General Motors

Corsa 1994-2001. Tecla baliza
sin piloto alarma color gris

I



V-1284

General Motors

Astra hasta 1999
tecla baliza simple

I



V-1285

General Motors

Astra hasta 1999 tecla baliza
c/testigo alarma

I



V-1326

General Motors

Meriva / Corsa II desde 2003
Tecla alzavidrios simple

I



V-1327

General Motors

Meriva / Corsa II desde 2003
Tecla alzavidrios doble

I



V-1328

General Motors

Meriva / Corsa II desde 2003
Tecla alzavidrios cuadruple

I



V-441

Ford

Escort 1992 / 1994. Tecla alzacristal
simple terminales planos

I



V-445

Ford

Escort todos hasta 1997. Tecla alza-
cristal simple terminales redondos

I



V-459

Ford

F-100 1993/1997
Tecla alzacristal simple

I



V-464

Ford

Ka hasta 1999
Tecla baliza

I



V-986

Ford

Falcon desde 1983. Tecla
luces exteriores

N



V-987

Ford

Falcon desde 1983. Tecla
luz interior

N



V-988

Ford

Falcon desde 1983. Tecla
lavaparabrisas

N



V-989

Ford

Falcon desde 1983. Tecla limpia-
parabrisas

N



V-990

Ford

Sierra
Tecla luneta termica

N



V-991

Ford

Sierra
Tecla alzacristal simple

N



V-1174

Ford

Escort / Mondeo
Tecla alzacristal simple trasera

I



V-1293

Ford

Escort desde 1997
Tecla alzacristal doble

I



V-460

Ford

Fiesta desde 1996
Tecla alzacristal doble

I



V-463

Ford

Ka desde 1996
Tecla alzacristal doble

I



V-461

Ford

Fiesta desde 1996
Tecla alzacristal simple

I



V-462

Ford

Ka desde 1996
Tecla alzacristal simple

I



V-1292

Ford

Ranger / Ecosport / Fiesta nuevo
hasta 2007 - tecla alzavidrios doble

I



V-1325

Ford

Ranger / Ecosport / Fiesta nuevo hasta
2007 - tecla alzavidrios cuadruple

I



V-1338

Ford

Ranger / Ecosport / Fiesta nuevo hasta
2007 - tecla alzavidrios simple

I



V-1420

Ford

F-100 F-250 Cargo tecla baliza
iluminada

I



V-553

Volkswagen

Gol / Senda / Saveiro hasta 1996
Tecla luces 2 posiciones.

N



V-554

Volkswagen

Gol / Senda / Saveiro hasta 1996
Tecla luces auxiliares

I



V-556

Volkswagen

Gol / Senda / Saveiro hasta 1996
Tecla baliza iluminada

I



V-568

Volkswagen

Gol AB9 desde 1996. Tecla
faro neblinero

I



V-573

Volkswagen

Gol AB9 desde 1996. Tecla alza-
cristal iluminada

I



V-578

Volkswagen

Gol ABP Country desde 1997
Tecla Faro neblinero

I



V-916

Volkswagen

Gol desde 1999. Tecla alzacristal
doble con bloqueo ventanas tras.

I



V-917

Volkswagen

Gol desde 1999. Tecla
alzacristal simple color negro

I



V-918

Volkswagen

Gol desde 1999.
Tecla alzacristal simple trasera

I



V-1072

Volkswagen

Gol desde 1999
Tecla faro auxiliar

I



V-1077

Volkswagen

Gol desde 1999
Tecla baliza

I



V-564

Volkswagen

Quantum
Tecla de Luces con reóstato

I



V-565

Volkswagen

Quantum
Tecla baliza



V-566

Volkswagen

Quantum
Tecla faro neblinero



V-1212

Volkswagen

Golf IV / Bora desde 2000
Tecla baliza



V-1213

Volkswagen

Passat
Tecla baliza



V-1214

Volkswagen

Polo hasta 2000
Tecla alza cristal



V-1215

Volkswagen

Quantum
Tecla luneta térmica



V-1216

Volkswagen

Passat
Tecla luneta térmica



V-1217

Volkswagen

Golf III 1996-2000
Tecla luneta térmica



V-1395

Volkswagen

Polo desde 2000
Tecla baliza con cuerpo horizontal



V-1396

Volkswagen

Polo desde 2000
Tecla alzacrystal simple secuencial



V-1270

Volkswagen

Golf 4 - Bora
Tecla alzacrystal



V-1305

Volkswagen

Gol Trend / Fox / Suran
Tecla alzavidrios simple





V-1307

Volkswagen

Gol Trend / Fox / Suran
Tecla alzavidrios doble



V-1359

Volkswagen

Bora /Golf IV - tecla alzavidrios
cuadruple c/cntrl. cierra de puertas



V-1394

Volkswagen

Vento / Bora nuevo tecla alzacristal
cuiadruple c/cierre



V-1381

Volkswagen

Fox / Suran / Crossfox desde 2009
Tecla baliza iluminada



V-1382

Volkswagen

Vento tecla baliza iluminada



V-1383

Volkswagen

Amarok tecla baliza iluminada



V-1419

Volkswagen

Gol Trend / Voyage tecla faros
auxiliares delanteros y traseros



V-1423

Volkswagen

Fox / Suran / Crossfox
tecla alzacristal trasera izquierda



V-1424

Volkswagen

Fox / Suran / Crossfox
tecla alzacristal trasera derecha



V-1162

Iveco

Eurocargo / Eurotech
/ Eurostar / Dayli. Tecla luces



V-1163

Iveco

Eurocargo / Eurotech / Eurostar
Dayli. Tecla faro retroneibla



V-1164

Iveco

Eurocargo / Eurotech / Eurostar
Dayli. Tecla faro neblinero





V-1165

Iveco

Eurocargo / Eurotech / Eurostar
Dayli. Tecla sirena / avisador

I



V-1166

Iveco

Eurocargo / Eurotech / Eurostar
Dayli. Tecla aire acondicionado

I



V-1167

Iveco

Eurocargo / Eurotech / Eurostar
hasta 2000 - tecla baliza

I



V-1168

Iveco

Eurocargo / Eurotech / Eurostar
desde 2000 - tecla baliza

I



V-972

Iveco

Camión. Tecla
limpiaparabrisas

N



V-973

Iveco

Camión. Tecla
bloqueo diferencial

N



V-974

Iveco

Camión. Tecla bocina,
sirena, avisador

N



V-975

Iveco

Camión.
Tecla luces 2 puntos

N



V-976

Iveco

Camión.
Tecla luces 1 punto

N



V-977

Iveco

Camión.
Tecla calefactor

N



V-978

Iveco

Camión
Tecla baliza iluminada

N



V-979

Iveco

Camión
Tecla baliza no iluminada

N



V-980

Iveco

Camión
Tecla faro antiniebla

N



V-1413

Iveco

Stralis tecla baliza iluminada

I



V-1332

Suzuki

Fun - tecla alzavidrios simple

I



V-1422

Toyota

Hilux tecla baliza hasta 2003

I

Fiat

Peugeot

Renault

Citröen

General Motors

Ford

Volkswagen

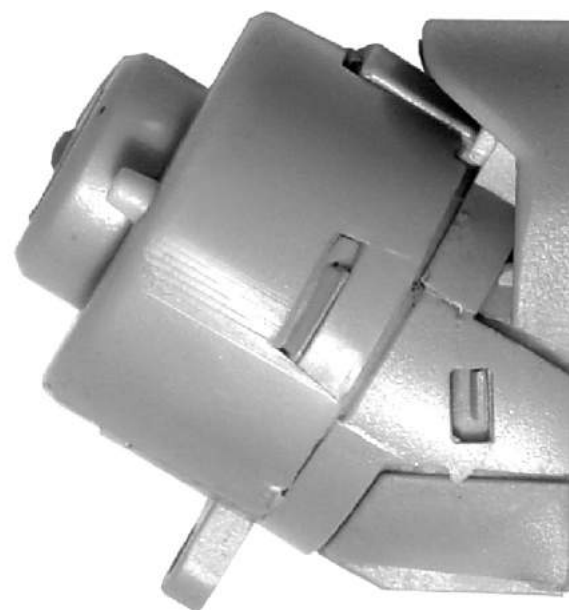



V-847

Fiat

Spazio / 147 / 128 Europa

N



V-942

Fiat

Duna / Uno / Regatta

N



V-943

Fiat

Duna / Uno
(arranque Marelli)

N



V-944

Fiat

Regatta modelo viejo

N



V-945

Fiat

600 / 1500
(4 terminales)

N



V-1033

Fiat

Palio / Siena todos

N



V-1339

Fiat

Palio / Siena desde 2000
(6 terminales gruesos + 1 terminal fino)

I



V-860

Peugeot

504 GR II

N



V-861

Peugeot

505 desde 1986

N



V-946

Peugeot

205 todas las versiones

N



V-947

Peugeot

404
(5 terminales)

N



V-948

Peugeot

404 diesel
(4 terminales)

N

Interruptores de ignición
Ignition switches



V-1113

Peugeot

405 todas las versiones

N



V-1114

Peugeot

306 primera serie (hasta 1998)

N



V-1115

Peugeot

306 segunda serie (desde 1998)

N



V-1116

Peugeot

Partner

N



V-1186

Peugeot

206 hasta 2001

N



V-1187

Peugeot

206 desde 2001

N



V-862

Renault

12 todas las versiones
hasta 1979

N



V-863

Renault

12 todas las versiones
desde 1979

N



V-864

Renault

Torino todas las versiones
desde 1980

N



V-865

Renault

18 y Fuego

N



V-866

Renault

9 / 11 / 4 GTL / Traffic

N



V-867

Renault

21 todas las versiones

N



V-941 **Renault**
19 / Clio primera serie
N



V-949 **Renault**
Express
N



V-1076 **Renault**
Megane - todas las versiones
N



V-1118 **Renault**
Clio II - segunda serie
N



V-1119 **Renault**
Kangoo / Twingo
N



V-1116 **Citröen**
Berlingo
N



V-1177 **General Motors**
Corsa / D-20
(4 terminales)
N



V-1178 **General Motors**
Corsa / Vectra / Monza
(5 terminales)
N



V-1220 **General Motors**
Corsa diesel
I



V-1272 **General Motors**
Astra hasta 1997 / Vectra
interruptor de ignición
I



V-1425 **General Motors**
Astra desde 1997 / Vectra
interruptor de ignición
I



V-895 **Ford**
F-100 / Galzaxy
N

Interruptores de ignición
Ignition switches



V-896

N

Ford
Escort hasta 1994



V-897

N

Ford
Orion desde 1994



V-898

N

Ford
Sierra



V-915

N

Ford
Camion Cargo



V-950

N

Ford
Taurus



V-951

N

Ford
Escort desde 1998



V-952

N

Ford
Fiesta / Ka

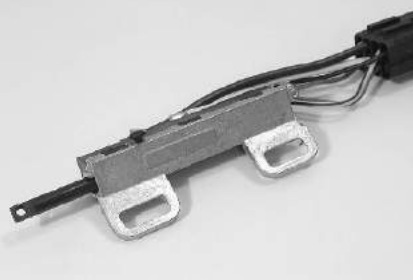

V-953

N

Ford
Falcon 1978 / 1988



V-922

N

Volkswagen
Gol / Senda / Saveiro hasta 1995
(primera serie)



V-924

N

Volkswagen
Gol / Saveiro desde 1996
(4 terminales)



V-925

N

Volkswagen
Gol / Saveiro desde 1996
(5 terminales)



V-926

N

Volkswagen
Golf mexicano
(5 terminales)



V-954

N

Volkswagen

Polo hasta 1999
(6 terminales)



V-1221

I

Volkswagen

Polo desde 2000
modelo nuevo



V-1426

I

Volkswagen

Golf IV - Bora - A3. Desde 2000
Interruptor de ignición



V-1398

I

Mercedes Benz

Sprinter interruptor de ignición

Fiat

Peugeot

Renault

General Motors

Ford

Volkswagen





V-254/I



Bomba elect. Walbro multipunto.
Presión 3,0 bar. Aplicación: Palio
Siena MPI, Escort, Orion,
Pointer MPI, Polo - Gol MPI , etc.



V-319/I



Bomba elect. Walbro monopunto
Presión 1,2 bar. Aplicación : Palio
Siena SPI, Escort, Orion, Pointer SPI
Polo SPI , etc.



V-320/I



Bomba elect. multipunto Bosch
3,0 bar. Aplicación : Renault 19,
Corsa, Vectra, Astra MPI
Tipo, S-10, Blazer MPI , etc.



V-321/I



Bomba electrica Bosch monopunto
1,2 bar. Aplicación: Uno 70ie / Tipo
/ Tempra , etc.



V-324



Bomba de cebado VDO 0,5 bar
Aplicación : 505 SRI / 405 hasta
1993 Renault 21 TXI /Quantum
Galaxy, etc.



V-346/I



Bomba pico a pico Universal Bosch
+ de 3,00 bar. Aplicación : 405
Bmw / Audi / Competición , etc.



V-322/I



Bomba multipunto Walbro alta
presión + 5,00 bar. Aplicación:
Ford F-100 4,9 / Ford Ranger
motores de alta cilindrada.



V-1185



Bomba electrica tipo VDO
3,0 bar. Aplicación: línea VW

Tabla de Equivalencias OEM Codes



Cód. VuaRam	Nro. original (OEM)	Referencia
V-09	4.223.770	Fiat
V-10	1.473.229	Fiat
V-12	1.471.071	Fiat
V-14	1.471.172	Fiat
V-16	1.471.173	Fiat
V-18	94.001.524	Fiat
V-20	94.001.525	Fiat
V-22	94.002.046	Fiat
V-23	1.477.171	Fiat
V-30	A.345.545.71.24	M.Benz
V-30/1	A.364.545.74.24	M.Benz
V-30/2	A.308.545.70.24	M.Benz
V-30/3	A.364.545.70.24	M.Benz
V-30 A	A.345.545.71.24	M.Benz
V-30/1A	A.364.545.74.24	M.Benz
V-30/2A	A.308.545.70.24	M.Benz
V-30/3 A	A.364.545.70.24	M.Benz
V-30 B	A.345.545.71.24	M.Benz
V-30 /1B	A.364.545.74.24	M.Benz
V-30/2 B	A.308.545.70.24	M.Benz
V-30/3 B	A.364.545.70.24	M.Benz
V-30/7	6885407045	M.Benz
V-30/8	6955407045	M.Benz
V-31	94.001.911	Fiat
V-34	94.001.911	Fiat
V-36	94.002.046	Fiat
V-39	6240.881	Peugeot
V-40	6240.882	Peugeot
V-41	6240.883	Peugeot
V-41/1	6240.884	Peugeot
V-42	21011.379310.80	Lada
V-49	BAEODZ-9275-A	Ford
V-50	94.003.777	Fiat
V-51	4.003.375	Fiat
V-52	94.000.878	Fiat
V-53	1.471.481	Fiat
V-54	1.479.744	Fiat
V-55	4.302.526	Fiat
V-56	94.002.082	Fiat
V-57	94.002.083	Fiat
V-58	4.067.627	Fiat

Cód. VuaRam	Nro. original (OEM)	Referencia
V-59	1.526.552	Peugeot
V-60	1.526.384	Peugeot
V-61	1.526.393	Peugeot
V-61/IT	1.526.394	Peugeot
V-62	1.526.553T	Peugeot
V-62/1	1.526.554	Peugeot
V-66	7135322	Iveco
V-68	94.002.199	Fiat
V-70	7.587.510	Fiat
V-70/1	94.004.436	Fiat
V-70/2	94.005.407	Fiat
V-70/3	5962053	Fiat
V-201	7702020710	Renault
V-202	7700687108	Renault
V-203	7702072736	Renault
V-204	7702071931	Renault
V-205	7700687109	Renault
V-206	7700387111	Renault
V-207	7702082736	Renault
V-208	7702089730	Renault
V-209	7702089693	Renault
V-210	3445427217	M.Benz
V-211	3445547212	M.Benz
V-212	3445547212	M.Benz
V-220	71919051	Ford
V-222	52251427	General Motors
V-223	52251426	General Motors
V-224	93206607	General Motors
V-227	93250758	General Motors
V-229	93284788	General Motors
V-239	71132	Sidat
V-240	71134	Sidat
V-240/1	71138	Sidat
V-247	377.998.051-A	Vw
V-248	325.998.051-1	Vw
V-249	547.998.051-B	Vw
V-251	7078916	Fiat
V-254/1	ERJ 240	Walbro
V-261	80TR8575A	Ford
V-262	BAE4TZ9275C	Ford
V-263	BAE4DS9275C	Ford

Cód. VuaRam	Nro. original (OEM)	Referencia
V-264	74BR9275B	Ford
V-265	80BR9275A	Ford
V-266	BAE4DZ9275C	Ford
V-267	BAE4DZ9275F	Ford
V-268	BAE7DZ9275A	Ford
V-271	71301229	Ford
V-272	4059381	Vw
V-273	4059383	Vw
V-274	ZAD919051	Vw
V-275	3021990511	Vw
V-276	3029190512	Vw
V-277	86BR9275A	Ford
V-278	86DR9275B	Ford
V-279	BAE4TZ9275A	Ford
V-280	BAE4DS9275B	Ford
V-304	6253.38	Peugeot
V-305	6253.41	Peugeot
V-306	7700760825	Renault
V-308	7701349882	Renault
V-310	7702072800	Renault
V-311	7700784185	Renault
V-314	1525.24	Peugeot
V-315	1525.19	Peugeot
V-316	1525.82	Peugeot
V-317	1527.96	Peugeot
V-319/1	ERJ 197	Walbro
V-320/1	0580-453-477	Bosch
V-321/1	0580-453-514	Bosch
V-322/1	ESS 287	Walbro
V-346/1	0580-464-038	Bosch
V-401	1898140	Fiat
V-404	1825471800	Fiat
V-405	1830284800	Fiat
V-417	735265337	Fiat
V-418	735265340	Fiat
V-421	337953513205	Ford
V-422	3379535192	Ford
V-424	81AG 13B 302 AA	Ford
V-425	T71953513A	Ford
V-426	T71953519A	Ford
V-429	TJG953513	Ford

Cód. VuaRam	Nro. original (OEM)	Referencia
V-430	TJG953519A	Ford
V-432/1	95AG-11K665-AA	Ford
V-433/1	95AG-14K147-CA	Ford
V-434/1	95AG-14K147-CA	Ford
V-435/1	98FU-13335-BA	Ford
V-436/1	98FU-13335-AA	Ford
V-437/1	95KG-14K147-CB	Ford
V-441	ZBY959855	Ford
V-445	L83B614529AA	Ford
V-459	T71 959 855	Ford
V-460	96FG 14529 BC	Ford
V-461	96FG 14529 AC	Ford
V-462	96FG 14529 AC	Ford
V-463	96FG 14529 BC	Ford
V-500	347 893	Scania
V-501	330 982	Scania
V-502	5974194	Fiat
V-506	1819802	Fiat
V-506/1	1819802 SM	Fiat
V-507	1819801	Fiat
V-507/1	1819801 SM	Fiat
V-511	181859280	Fiat
V-512	750554B	Fiat
V-513	1807497800	Fiat
V-514	1807660583	Fiat
V-515	1803720800	Fiat
V-519	6552.A0	Peugeot
V-520	6552.A3	Peugeot
V-522	6552.A1	Peugeot
V-523	6552.W3	Peugeot
V-524	6552.V0	Peugeot
V-531	6552.Z0	Peugeot
V-532	6552.V1	Peugeot
V-533	6552.60	Peugeot
V-534	6552.WJ	Peugeot
V-534/1	6552.WJ	Peugeot
V-535	6552.W0	Peugeot
V-535/1	6552.W0	Peugeot
V-536	5942615	Fiat
V-544	5893359	Fiat
V-545	5893359	Fiat

Tabla de Equivalencias OEM Codes



Cód. VuaRam	Nro. original (OEM)	Referencia
V-546	5894043	Fiat
V-547	1482560	Fiat
V-553	3079415313	Vw
V-554	3079915311	Vw
V-556	307.953.235.1	Vw
V-564	325 941 531 I	Vw
V-565	325 953 235 I	Vw
V-566	325 341 535 I	Vw
V-568	3779453505	Vw
V-573	377959855A	Vw
V-578	3779453505	Vw
V-579	373941534D	Vw
V-580	373941534C	Vw
V-581	377953513A	Vw
V-583/1	547-953505-C	Vw
V-584/1	547-953505-D	Vw
V-586	377953519A	Vw
V-589	377953513	Vw
V-596	6K5953513AB41	Seat
V-595/1	86AG13B302AA	Ford
V-804	52255891	General Motors
V-806	90181853	General Motors
V-807	90434501	General Motors
V-807/1	90434501	General Motors
V-810	90181583	General Motors
V-818 A	90213283	General Motors
V-818/1 A	90381877	General Motors
V-820	90191678	General Motors
V-821/1	90508667	General Motors
V-827	90243394	General Motors
V-828	90243395	General Motors
V-843	716719614	Fiat
V-844	716133614	Fiat
V-845	717135614	Fiat
V-846	717137614	Fiat
V-847	036003 / 036004	Valeo
V-860	026002	Valeo
V-861	026005	Valeo
V-862	046002	Valeo
V-863	046006	Valeo
V-864	046005	Valeo

Cód. VuaRam	Nro. original (OEM)	Referencia
V-865	7702073023	Renault
V-866	7702073688	Renault
V-867	7700766093	Renault
V-895	307.905.865.1	Vw
V-896	86-AU-11572-A	Ford
V-897	91-AB-11572-AA	Ford
V-898	81-AB-11572-AB	Ford
V-916	373959851G	Vw
V-917	377959855B/C	Vw
V-918	373959851G	Vw
V-920	377953513A	Vw
V-921	37793519A	Vw
V-922	307.905.865.1	Vw
V-924	377.805.865	Vw
V-925	377.905.865.2	Vw
V-926	377.905.865.2	Vw
V-941	7700805669	Renault
V-942	870057	Valeo
V-943	7077415	Fiat
V-944	870056	Valeo
V-945	036002	Valeo
V-947	026001	Valeo
V-948	026003	Valeo
V-949	7700813973	Renault
V-950	77-BR-11272-A	Ford
V-951	89-FB-11572-AB	Ford
V-952	89-FB-11572-AB	Ford
V-953	SW 992	Ford
V-954	357.905.865	Vw
V-956	1481918	Fiat
V-957	1481915	Fiat
V-958	1483638	Fiat
V-959	1481918	Fiat
V-964	6550.711	Peugeot
V-965	9418527893	Peugeot
V-966	6550.211	Peugeot
V-967	6550.231	Peugeot
V-968	9418529437	Peugeot
V-969	6550.241	Peugeot
V-970	9418529445	Peugeot
V-971	9418529439	Peugeot

Cód. VuaRam	Nro. original (OEM)	Referencia
V-972	4214300	Fiat
V-975	4218245	Fiat
V-977	4218470	Fiat
V-981	A3415457211	M.Benz
V-986	82DR 11653A	Ford
V-987	82DR 13713A	Ford
V-988	82DR 17A625A	Ford
V-989	82DR 17A553A	Ford
V-990	82DR 18C621A	Ford
V-991	L83B61429AA	Ford
V-996	6239.71	Peugeot
V-998	6253.56	Peugeot
V-1000	6253.69	Peugeot
V-1002	6253.70	Peugeot
V-1004	6253.65	Peugeot
V-1006	6253.65	Peugeot
V-1010	7700797804	Renault
V-1011	7700842114	Renault
V-1030	A 000 540 7445	M.Benz
V-1033	46543405	Fiat
V-1040	96115649XT	Peugeot
V-1052	7700708870	Renault
V-1053	770797788	Renault
V-1054	7700802566	Renault
V-1057	7700802564	Renault
V-1058	6000070876	Renault
V-1059	7700817337	Renault
V-1063	7700307605	Renault
V-1069	7700817335	Renault
V-1071		Renault
V-1072	893941563	Vw
V-1073	7702089674	Renault
V-1074	7700305346	Renault
V-1075	7702061628	Renault
V-1076	7701469419	Renault
V-1077	377953235	Vw
V-1078	7700557583	Renault
V-1079	6552.67	Peugeot
V-1082	6253.79	Peugeot
V-1082/1	6253.65	Peugeot
V-1083	377941534G	Vw

Cód. VuaRam	Nro. original (OEM)	Referencia
V-1089	8200523539	Renault
V-1113	4100001A	Valeo
V-1114	4009000B	Valeo
V-1115	90090000A	Valeo
V-1116	9499010	Valeo
V-1118	7701471220	Renault
V-1119	77001470736	Renault
V-1120	7700839681	Renault
V-1121	7701046629	Renault
V-1124	1C0941531A	Vw
V-1125	4B0.953.503F	Vw
V-1126	4B0.953.503H	Vw
V-1127	6253.77	Peugeot
V-1141	735241456	Fiat
V-1142		Fiat
V-1153	7700705925	Renault
V-1155	6253.66	Peugeot
V-1158		Peugeot
V-1162	4854433	Iveco
V-1163	4854426	Iveco
V-1164	4854425	Iveco
V-1165	99460121	Iveco
V-1166	98181410	Iveco
V-1167	500362382	Iveco
V-1168	4840891	Iveco
V-1170		Fiat
V-1171		Fiat
V-1172		Fiat
V-1173		Fiat
V-1174	93BG 14529 AA	Ford
V-1177	90.052.498	General Motors
V-1178	90.052.498	General Motors
V-1185	1 Ho-906-0911	Vw
V-1186	9064 - 9638	Valeo
V-1187	9639 - 9681	Valeo
V-1191	735290065	Fiat
V-1194	7081972	Fiat
V-1212	1 J0 953 235 J	Vw
V-1213		Vw
V-1214	321 959 855	Vw
V-1215	325959621 I	Vw

Tabla de Equivalencias OEM Codes



Cód. VuaRam	Nro. original (OEM)	Referencia
V-1216		Vw
V-1217		Vw
V-1218	8Lo 953 513 G	Vw
V-1219	8Lo 953 513 G	Vw
V-1220	90389377	General Motors
V-1221	4B0-905849	Vw
V-1222	1F2Z 13K359 AAAl	Ford
V-1223	7701048956	Renault
V-1224	7701048957	Renault
V-1225	7701054108	Renault
V-1226	7701047652	Renault
V-1227	7701047653	Renault
V-1228	7701047254	Renault
V-1229	7701047225	Renault
V-1230	251927	Renault
V-1231	251928	Renault
V-1232	251930	Renault
V-1233	251930	Renault
V-1234		Ford
V-1235		Ford
V-1236		Ford
V-1237		Ford
V-1239	6253.68	Peugeot
V-1240		Peugeot
V-1241		Peugeot
V-1243	6253.67	Peugeot
V-1244		Peugeot
V-1252	6001030110	Renault
V-1260	2S65 9A299 AC	Ford
V-1261	93285494	General Motors
V-1262	8200134709	Renault
V-1263	7521088	Fiat
V-1266	93376193	General Motors
V-1267	93310219	General Motors
V-1268	2M35 9A299 AA	Ford
V-1269	4B0941509D	Vw
V-1270		Vw
V-1272	90505912	General Motors
V-1273		Vw
V-1275	93250758	General Motors
V-1276	93394079	General Motors

Cód. VuaRam	Nro. original (OEM)	Referencia
V-1278	98AP 9H307 AL	Ford
V-1279	7700802566	Renault
V-1280	1191426600	Fiat
V-1281	1191425600	Fiat
V-1282	52274901	General Motors
V-1283	52274900	General Motors
V-1284	91038059	General Motors
V-1285	91038060	General Motors
V-1286		General Motors
V-1287		General Motors
V-1288		General Motors
V-1289	0085450124	M. Benz
V-1292	2S6514529BB	Ford
V-1293	95AG 14529 BA	Ford
V-1294	7701348545	Renault
V-1295		Renault
V-1301	7700817339	Renault
V-1302	7700794670	Renault
V-1303	7700807537	Renault
V-1304	7700807538	Renault
V-1305	4854426	Vw
V-1307	7EO 959 8555A	Vw
V-1311	7700432963	Renault
V-1312	7700838101	Renault
V-1313	7700430000	Renault
V-1314	7700430001	Renault
V-1315	7700838102	Renault
V-1316	77004299981	Renault
V-1317	7700436529	Renault
V-1318	7700838099	Renault
V-1319	7700429999	Renault
V-1320	7700838100	Renault
V-1321	7700425387	Renault
V-1322	7700425386	Renault
V-1323	7700838098	Renault
V-1324	7700838097	Renault
V-1325	7S65 14529 AA	Ford
V-1326	90561388	General Motors
V-1327		General Motors
V-1328		General Motors
V-1330		Fiat

Cód. VuaRam	Nro. original (OEM)	Referencia
V-1331	716133614	Fiat
V-1332	03 1647 501	Suzuki
V-1333		Renault
V-1334	93-378.440	Suzuki
V-1335	100185360	Fiat
V-1336	110185555	Fiat
V-1337	8200442724	Renault
V-1338	2S65 14529 AA	Ford
V-1339	46806589	Fiat
V-1340	C9TT11652	Ford
V-1341	7C9TT11654	Ford
V-1342	BAC-8DZ-13341	Ford
V-1343	BAC-9DZ-13341	Ford
V-1344	BAC-7TZ-13341	Ford
V-1345	BAC-9TZ-13341	Ford
V-1346	BAC-D4TZ-13341	Ford
V-1347	5753232	Ford
V-1348	5747493	Ford
V-1349		Ford
V-1350		Ford
V-1351		Ford
V-1352	BAC-D8DZ-13341	Ford
V-1353	BA-D9DZ-13341-4	Ford
V-1354	BA-D9DZ-13341-A	Ford
V-1355	BA-D8TZ-13341-A	Ford
V-1356	BA-E2DZ-13305-A	Ford
V-1357	BA-E2DZ-13305-A	Ford
V-1358	BA-E2DZ-13305-A+	Ford
V-1359		Vw
V-1360	7700801669	Renault
V-1361	8200128479	Renault
V-1362	7701472425	Renault
V-1363	5Z0953513	Vw
V-1364	5Z0953513C	Vw
V-1365	5Z0953503A	Vw
V-1366	5Z0953503B	Vw
V-1367		Vw
V-1368	8200602227	Renault
V-1370	6490	Peugeot
V-1371	6490	Peugeot
V-1372	6490.L3	Peugeot

Cód. VuaRam	Nro. original (OEM)	Referencia
V-1373	6490.J0	Peugeot
V-1374		Universal
V-1375		Universal
V-1376		Universal
V-1381	5Z0.953.235.C	Vw
V-1382		Vw
V-1383		Vw
V-1385	8200310034	Renault
V-1388	735333496	Fiat
V-1389	735333486	Fiat
V-1390	735335235	Fiat
V-1391	7354423260	Fiat
V-1392	7354423290	Fiat
V-1393	7354423320	Fiat
V-1394	1K495987B	Vw
V-1395		Vw
V-1396		Vw
V-1398	A 000 545 8108	M.Benz
V-1400	5X3.998.134	Vw
V-1401	5X7.998.134	Vw
V-1402	5Z0.919.673	Vw
V-1403	1J0.919.673H	Vw
V-1404	XS41.9275.BB	Ford
V-1405	BG1A.9A213.AA	Ford
V-1406	5L55.9A299.CA	Ford
V-1407		Renault
V-1408		Renault
V-1409	1525.NW	Peugeot
V-1410	1525.NY	Peugeot
V-1411	7086630	Fiat
V-1412	7085771	Fiat
V-1413	504097210	Iveco
V-1414		M.Benz
V-1415	100185212	Fiat
V-1416	100185213	Fiat
V-1417		Fiat
V-1418		Fiat
V-1419	5U0.941.535	Vw
V-1420	88HU.13A350.AA	Ford
V-1421	386.545.70.24	M.Benz
V-1422		Toyota

Tabla de Equivalencias OEM Codes



Cód. VuaRam	Nro. original (OEM)	Referencia
V-1423	6Q0.959.855	Vw
V-1424	6Q0.959.856	Vw
V-1425	90589314	General Motors
V-1426	4AO.905.849B	Vw
V-1427		General Motors
V-1428		Renault
V-1429		Renault
V-1430		Renault
V-1431		Ford
V-1432	52250869	General Motors
V-1433		Dodge
V-1434		John Deere
V-1435		John Deere
V-1436		John Deere
V-1437		John Deere
V-1438		M. Ferguson
V-1439		M. Ferguson
V-1440		M. Ferguson
V-1441		Zanello
V-1442		Zanello
V-1443		Zanello
V-1444		Deutz Fahr
V-1445		Deutz Fahr
V-1446		Deutz Fahr
V-1447		Deutz Fahr
V-1448		Yale
V-1449		Yale







Fabricación - Comercialización

Distribuidor nacional

